

AIPHONE

IS SERIES

Commercial & Security Video Intercom system

Local System

OPERATION MANUAL

GETTING STARTED

SETTING AND ADJUSTMENT

USING THE SYSTEM

APPENDIX

Thank you for selecting Aiphone for your communication and security needs. Please read this manual and the separate "SETTING MANUAL" carefully before setting and using this system.

* Please make sure to read this manual for safe and correct use of the system, and keep it in a safe place for future reference.

Please note that images and illustrations depicted in this manual may differ from the actual ones.

CONTENTS

INTRODUCTION.....	4
PRECAUTIONS	4
WARNING	4
CAUTION	4
GENERAL PRECAUTIONS	4
Notes on using this system	5
Notices.....	5

GETTING STARTED 6

PART NAMES..... 6

Color monitor master station (IS-MV)	6
■ Control panel.....	6
■ Monitor	7

Vandal-resistant video door station (IS-DV and IS-DVF), vandal-resistant audio door station (IS-SS, IS-SS-2G)..	9
---	---

Room sub station (IS-RS)	10
--------------------------------	----

OUTLINE OF OPERATIONS 11

Communication.....	11
Transferring.....	11
Paging.....	12
Monitoring	12
Door release.....	12

SETTING AND ADJUSTMENT 13

MASTER STATION SETTINGS AND ADJUSTMENTS..... 13

Setting items	13
Setting the display language	14
Adjusting screen brightness [BRIGHTNESS].....	14
Adjusting sound volume [TONE VOL], [RECEIVE VOL].....	14
Initial settings [INITIAL SETTING].....	15

USING THE SYSTEM..... 19

RECEIVING AND ANSWERING A CALL ON THE MASTER STATION 19

Receiving a call.....	19
-----------------------	----

Answering a call	19
------------------------	----

- Communication in the hands-free mode.....19
- Communication in the press-to-talk mode.....20
- Communication by using the handset...20

Viewing video images of the caller (at a video door station)... 21

- Switching Zoom/Wide.....21
- Pan & Tilt.....21
- Adjusting images 22 |

Transferring to another master station 23

- Communication transferring 23 |
- Call transferring 23 |

Door release 24

Using the PRIVACY function..... 24

PERFORMING CALLING, MONITORING, PAGING AND CHIME PAGING ON THE MASTER STATION 25

Searching for a station or zone ... 25

- Searching for a station or zone from the list.....27
- Searching for a station or zone by number using the dial keys 29 |
- Searching for a station or zone from the placed call or received call list.....30
- Selecting a station or zone by using the speed dial buttons.....30

Calling another station (direct voice call)	31
Monitoring	32
■ Monitoring.....	32
■ Scan-monitoring	32
Viewing video images at the target station.....	32
Paging	33
Chime paging	33
OTHER FUNCTIONS (combined with connected external devices)	34
Activating room sub stations, IS-SS-2G audio door stations and central control units by detecting contact input	34
Activating an external device by detecting the designated action ...	34
APPENDIX.....	35
TECHNICAL PRECAUTIONS ...	35
AVAILABLE CHARACTER LIST	35
SPECIFICATIONS	36
WARRANTY.....	38

INTRODUCTION

The IS system is a commercial and security video intercom system especially designed for applications in facilities such as office buildings, factories, schools, hospitals, and prisons. Installed separately from conventional general-purpose internal communications systems, the IS system can be used as a video door entry system, emergency announcement system, rescue assistance system, urgent call system, public announcement system, and access control system.

PRECAUTIONS

- ⊘ General Prohibitions
- ⊘ Prohibition to Dismantle the Unit
- ⊘ Prohibition on Subjecting the Unit to Water
- ❗ General Precautions

WARNING

Negligence could result in death or serious injury.

- ⊘ 1. Do not dismantle or alter the unit. Fire or electric shock could result.
- ⊘ 2. Keep the unit away from water or any other liquid. Fire or electric shock could result.
- ⊘ 3. High voltage is present internally. Do not open the case. Electric shock could result.
- ⊘ 4. Do not connect any non-specified power source to the +, - terminals. Also, do not install two power supplies in parallel to a single input. Fire or damage to the unit could result.
- ⊘ 5. Do not connect any terminal on the unit to an AC power line. Fire or electric shock could result.
- ⊘ 6. Do not use power supply with a voltage other than specified. Fire or electric shock could result.
- ⊘ 7. Do not put any metal or flammable material into the unit through the openings. Fire, electric shock, or unit trouble could result.
- ⊘ 8. The unit is not explosion-proof. Do not install or use near gases or flammable materials. Fire or explosion could result.
- ❗ 9. Existing wiring such as chime wiring, etc. may contain high voltage AC electricity. Damage to the unit or electric shock could result. Wiring and installation should be done by a qualified technician.

CAUTION

Negligence could result in injury to people or damage to property.

- ⊘ 1. Do not install or make any wire terminations while power supply is plugged in. It can cause electrical shock or damage to the unit.
- ❗ 2. When mounting the unit on a wall, install the unit in a convenient location, but not where it could be jarred or bumped. Injury could result.
- ❗ 3. Before turning on power, make sure wires are not crossed or shorted. If not, fire or electric shock could result.
- ❗ 4. For power supply, use Aiphone power supply model or model specified for use with system. If non-specified product is used, fire or malfunction could result.
- ❗ 5. On products with ground terminals, connect to an earth ground. Fire or malfunction could result.
- ⊘ 6. Do not put anything on the unit or cover the unit with cloth, etc. Fire or unit trouble could result.

- ⊘ 7. Do not install the unit in any of the following locations. Fire, electric shock, or unit trouble could result.
 - * Places under direct sunlight or places near heating equipment that varies in temperature.
 - * Places subject to dust, oil, chemicals, hydrogen sulfide (hot spring).
 - * Places subject to moisture and humidity extremes, such as bathrooms, cellars, greenhouses, etc.
 - * Places where the temperature is quite low, such as inside a refrigerated area or in front of an air conditioner.
 - * Places subject to steam or smoke (near heating or cooking surfaces).
 - * Where noise generating devices such as dimmer switches or inverter electrical appliances are closeby.
 - * Locations subject to frequent vibration or impact.
- ⊘ 8. Do not press on the LCD or subject it to a high impact. The LCD glass could be punctured and result in an injury.
- ⊘ 9. If the LCD is punctured, do not allow skin contact with the liquid crystal inside. Inflammation could result.
 - * If liquid crystal is ingested, immediately gargle with water and seek medical attention.
 - * If contact with the eyes or skin occurs, clean with pure water for at least 15 minutes and seek medical attention.
- ❗ 10. Do not use the handset when you perform a call test or check the chime volume, otherwise it may cause damage to your ear. Be sure to use the built-in speaker.
- ❗ 11. Be sure to perform a call test or check the chime volume with the handset on the hook. If you operate the hook switch with the handset on your ear, a sudden call etc. may arrive causing damage to your ear.

GENERAL PRECAUTIONS

- 1. Keep the unit more than 1m (3.3') away from radio or TV set.
- 2. Keep the intercom wires more than 30cm (12") away from AC 100-240V wiring. AC induced noise and/or unit malfunction could result.
- 3. Install the unit in an area that will be accessible for future inspections, repairs, and maintenance.
- 4. As to other manufacturer's devices (such as sensor, detectors, door releases) used with this system, comply with the Specifications and Warranty conditions that the manufacturers or vendors present.
- 5. If the unit is down or does not operate properly, unplug the power supply or turn off the POWER switches.
- 6. When wall-mounted, the top of the unit may darken and sooty. This does not indicate a malfunction.
- 7. The unit case may become a warm with use, but this is not a unit malfunction.

8. If it is used close to a cellular phone, the unit may malfunction.
9. The unit can be damaged if dropped. Handle with care.
10. The unit turns inoperative during power failure.
11. In areas where broadcasting station antennas are close by, the intercom system may be affected by radio frequency interference.
12. All the units, except for door station, is designed for indoor use only. Do not use outdoor.
13. This product, being a control unit of door release, should not be used as a crime prevention device.
14. It must be noted in advance that the LCD panel, though manufactured with very high precision techniques, inevitably will have a very small portion of its picture elements always lit or not lit at all. This is not considered a unit malfunction.
15. Door station is weather-resistant, but do not spray high-pressure water. Unit trouble could result.
16. Due to the environmental sound around the unit, it may hinder smooth communication, but this is not a malfunction.
17. Refrain from using the color monitor station in sunlit areas.
18. At night, due to reduced lighting on the object, the monitor sees more noise and the face becomes more difficult to see, but this is not malfunction.
19. For the hands-free communication:
If you stand too far away, it may be difficult for the other person to hear the communication.
20. If there are loud noises around the unit (such as music playing or children crying), the sound may break up and be difficult to hear.
21. During communication, if you speak before the other person has finished talking, your voice may not come through clearly. Communication will proceed smoothly if you wait until the other person has finished before speaking.
22. At a gate or porch illuminated by a fluorescent lamp, the picture may vary, but this is not a malfunction.
23. The outline of video images displayed by video door station may differ from that of the actual person(s) or background, but this is not a malfunction.
24. If the surface of a video door station freezes during wintertime, the picture may become difficult to see or the call button (including the call button of audio door station) may not move, but this is not a malfunction.
25. Aiphone assumes no responsibility for corruption of saved information (such as changes to or deletion of saved information). Please be aware of this in advance.
26. Warm-color lighting shining on the video door station may change the tint of the picture on the monitor.
27. When outside temperature lowers sharply after rainfall, etc., the inside of the camera may fog up slightly, causing a blurry picture, but this is not a malfunction. Normal operation will be restored when moisture evaporates.
28. When talking continuously, the talking may be interrupted by the noise cut function because the continuous talk is regarded as a noise, but this is not a malfunction.
29. During monitoring, the noise cut function does not work for making outside sounds easy to hear, so the noise may be heard louder than during communication.
30. When the unit's screen is illuminated with strong light, the image looks white or silhouetted. But this is not a unit trouble.

Notes on using this system

- Depending on the network environment and computer, it may not be useable.
- You need to set the ID/password to access the web server when changing the system settings or doing the system maintenance. The system administrator must keep the ID/password without fail. If you forget the ID/password, you must initialize the unit, thus all the setting contents return to default.
- The ID/Password to access the web server for setting the system is the customer's responsibility. Make sure you set a password that cannot be easily guessed by a third party. We recommend that you change the ID/Password on a regular basis.
- You may not be able to operate stations while updating the System settings by using a PC.
- Video images and/or sounds may be interrupted depending on the communication status.
- **If you are experiencing difficulties in the use of the system, please check our website at <http://www.aiphone.net/>.** (Our website does not support IPv6.)

Notices

- We will under no conditions be liable for damage that occurs due to the inability to communicate due to malfunctions, problems, or operational errors in this product.
- We will under no conditions be liable for any damages or losses resulting from this product's contents or specifications.
- This manual was created by Aiphone Co., Ltd., all rights reserved. Copying a part of or this entire manual without prior permission from Aiphone Co., Ltd. is strictly forbidden.
- Please note that images and illustrations depicted in this manual may differ from the actual ones.
- Please note that this manual may be revised or changed without prior notice.
- Please note that product specifications may be changed for the sake of improvement without prior notice.
- Please be aware that it is the customer's responsibility to ensure that their computer is secure. We will under no conditions be liable for security failures.
- This system is not intended for life support or crime prevention. It is just a supplementary means of conveying information. Aiphone will under no conditions be liable for loss of life or property which occurs while the system is being operated.
- This system is not intended for preventing physical injury, accidents caused by disasters and property damage.
- When the web server is rebooted, all the registrations are returned to the settings that were made last time. Please make the settings again.

GETTING STARTED

PART NAMES

Color monitor master station (IS-MV)

■ Control panel

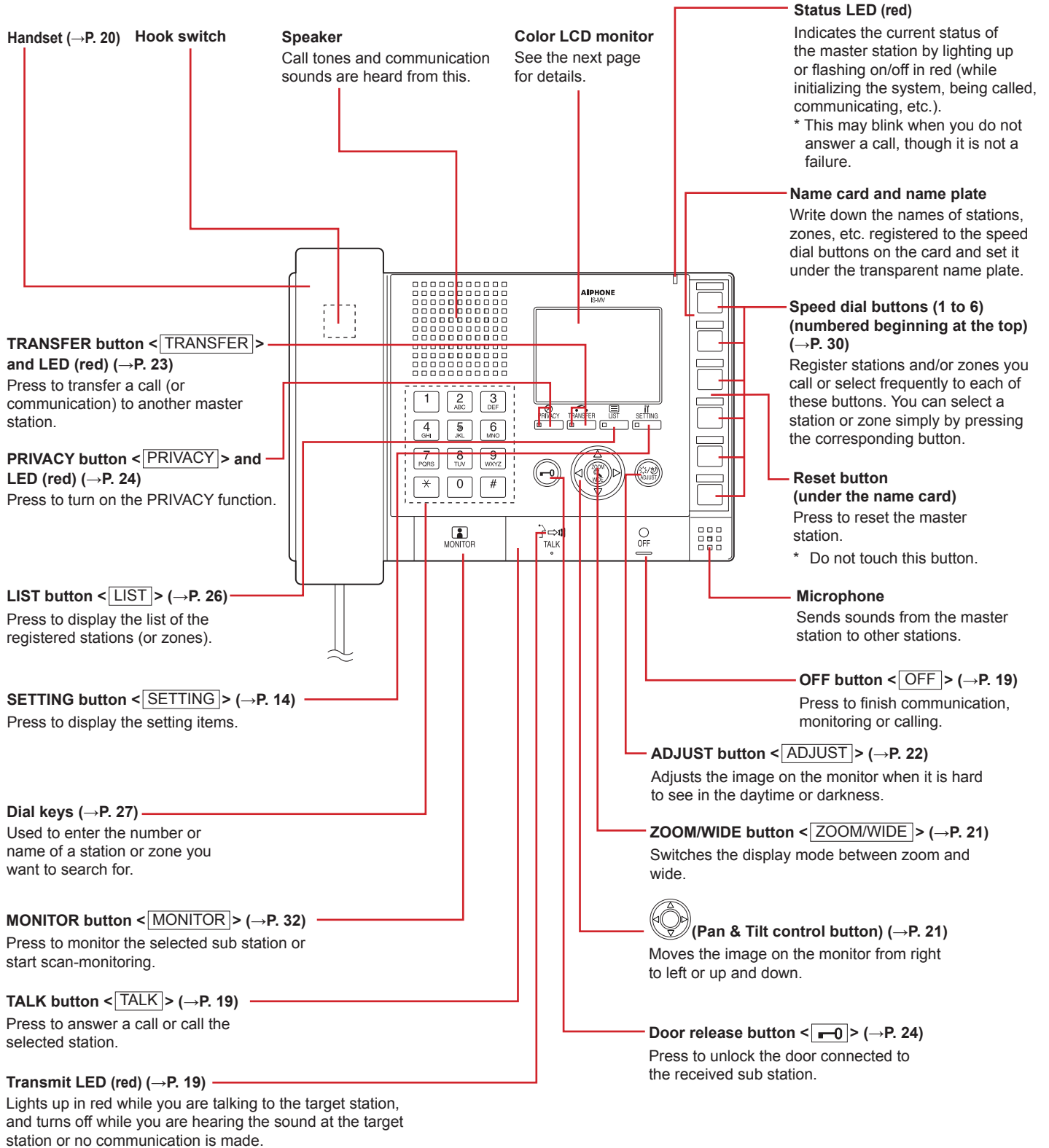

* The notation in < > is used for operational description in this manual.

Monitor

Display item examples

List of stations or zones (→P. 27)

The list of the stations or zones you searched for is shown here. Stations or zones are displayed either by number and/or name depending on the setting on the "INITIAL SETTING".

* "NOT AVAILABLE" appears in the list when a corresponding station or zone is not detected.

List page no. (→P. 15)

When the list of stations (and/or zones) or setting items consists of two or more pages, the current page no. is shown here.

Information display (→"USING THE SYSTEM")

Displays the name (or number) of selected or calling station, operation method, etc.

Status display icons

The following icons are displayed here depending on the status of the master station.

* The color of an icon changes according to the priority level.
Normal: green
Priority: yellow
Urgent: red

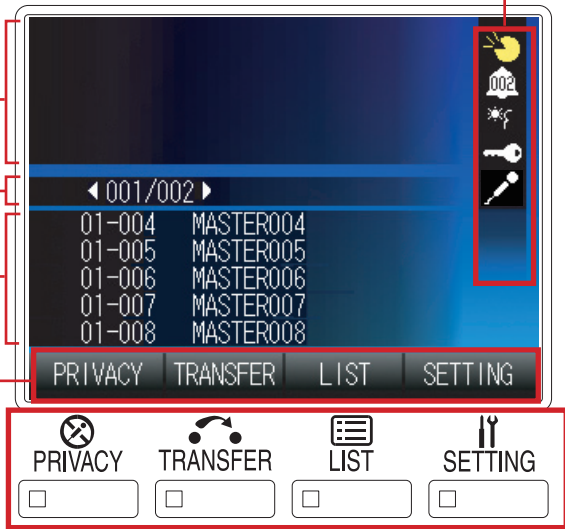

Icons	The status when the icon appears
	Appears while talking to the target station, being called from another master station, etc.
	Appears while being called.
	Appears while being called from two or more sub stations. (For example, "002" on the figure shows that 2 calls are coming in at the same time.) * There is a case that "001" appears on the icon when being called from a station while talking to another.
	Appears when paging.
	Appears when the image on the monitor is adjusted by pressing the [ADJUST] button.
	Appears while the door release is activated by pressing the door release button.
	Appears when the microphone volume is set to OFF, or the PRIVACY function is activated.
	Appears while transferring is suspended.
	Appears while receiving a call from a station transferred by another one. * This icon also appears on the station that performs transferring.
	Appears while searching for a station, area or zone.
	Appears while monitoring.
	Appears during scan-monitoring.
	Appears when an error message is displayed.
	Appears when a setting screen is displayed.
	Appears while performing chime paging.
	Appears when the microphone volume is set to ON.
	Shows it is a waiting time for shifting to the next performance, etc.

Function buttons

The function buttons are also enabled when the function indicators just above the buttons are displayed.

* The function name on an indicator may differ from the name of the corresponding button. In that case, the button operates as the function of the indicator.

Function indicators

The indicators differ depending on the display mode.

* These are not touch panel keys.

NOTE:

The above display example differs from the actual one.

Display examples

[Standby mode]

* The monitor with no display (black) may also be in the standby mode.

Date, time, station no. and name of this master station

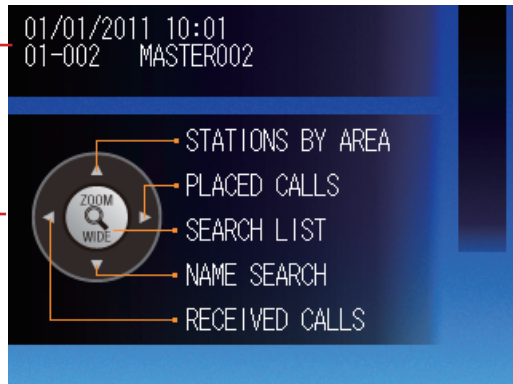

Key map for selecting the search items

[When talking with a door station]

Station no. and name of the target station or calling station

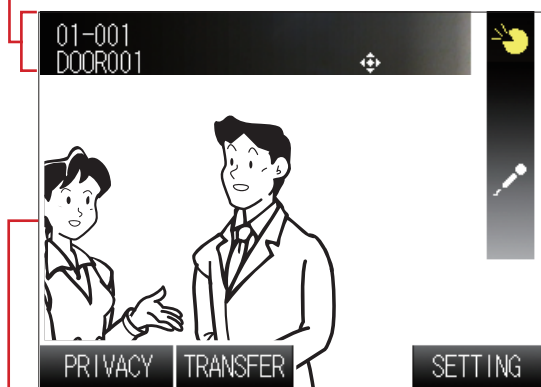

If the target station or calling station is a video door station, the video image at the station is displayed.

[When called from a room sub station]

Station no. and name of the calling station

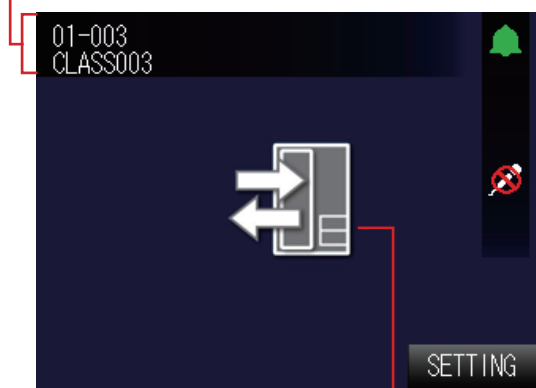

The calling station type image

If the target station or calling station is an audio door station, room sub station or master station, no video image is displayed.

Displaying call and/or (chime) paging record and reception record

Call and/or (chime) paging record and reception record can be displayed on the monitor for each up to 20 items.

* When no answer was returned to an incoming call from this master station, it is displayed in the reception record list. In the records, unanswered incoming calls are marked with ☆ (outlined in yellow) or ★.

★ : Unanswered calls that have not been confirmed on the list yet

☆ : Unanswered calls that have already been confirmed on the list

NOTES:

- The calls that are not received at the master station are not recorded.
- The record of unanswered incoming calls can also be automatically displayed by the setting on the "INITIAL SETTING". (→ P. 16)
- The reception of chime is not recorded.
- A monitoring operation is not recorded. If monitoring is shifted to talking, it will be recorded.

Vandal-resistant video door station (IS-DV and IS-DVF), vandal-resistant audio door station (IS-SS, IS-SS-2G)

Vandal-resistant video door station (surface-mount) (IS-DV)

White light LED

Lights up automatically when a call operation is made on this unit at night.

Name plate (with backlight)

Write down a name on the plate. The backlight is always lit while the power is on to make a visitor confirm the name even at night.

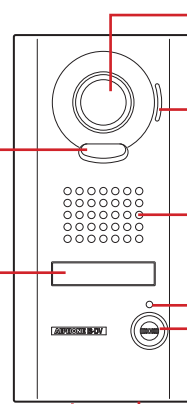

Camera (→P. 21)

Captures images to display on the monitor of the master station.

Microphone

Sends sounds from the door station to the master station.

Speaker

Outputs sounds from the master station.

Status LED (red/orange/green)

Indicates the current status (calling, talking, etc.) of this station by color.
e.g.) Lights up in orange in the standby mode.

Call button (→P. 19)

Calls the preset master stations.

Water escape holes

These are for discharging rain water inside the unit.
❗ Do not obstruct these holes.

Vandal-resistant video door station (flush-mount) (IS-DVF)

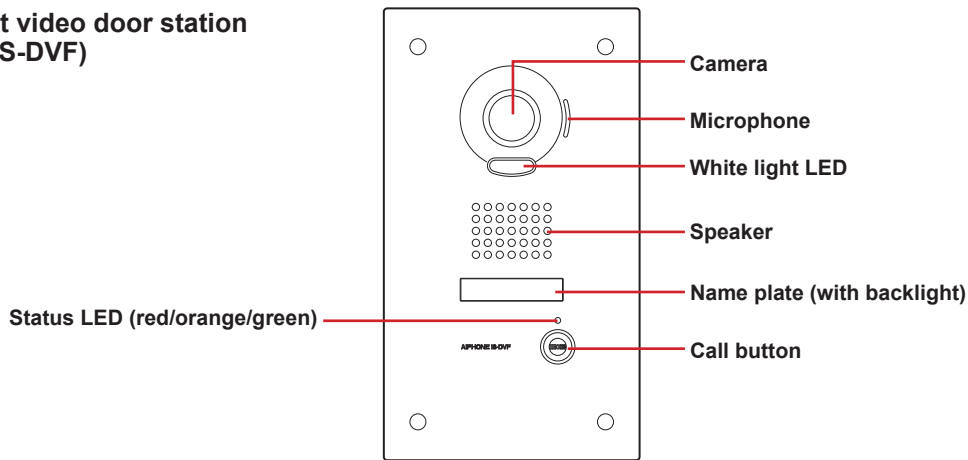

Vandal-resistant audio door station (flush-mount) (IS-SS, IS-SS-2G)

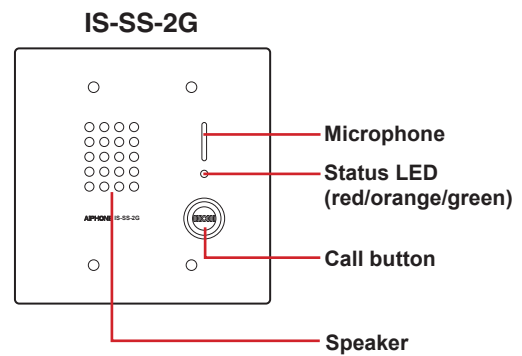
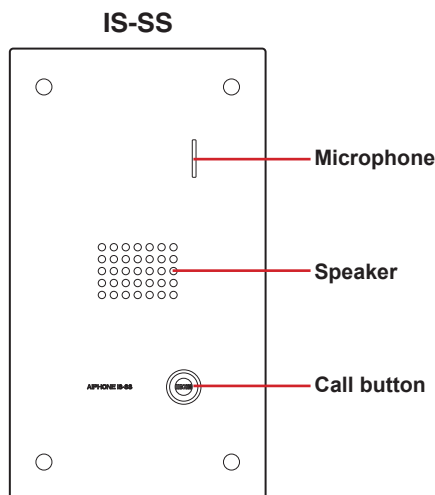

Room sub station (IS-RS)

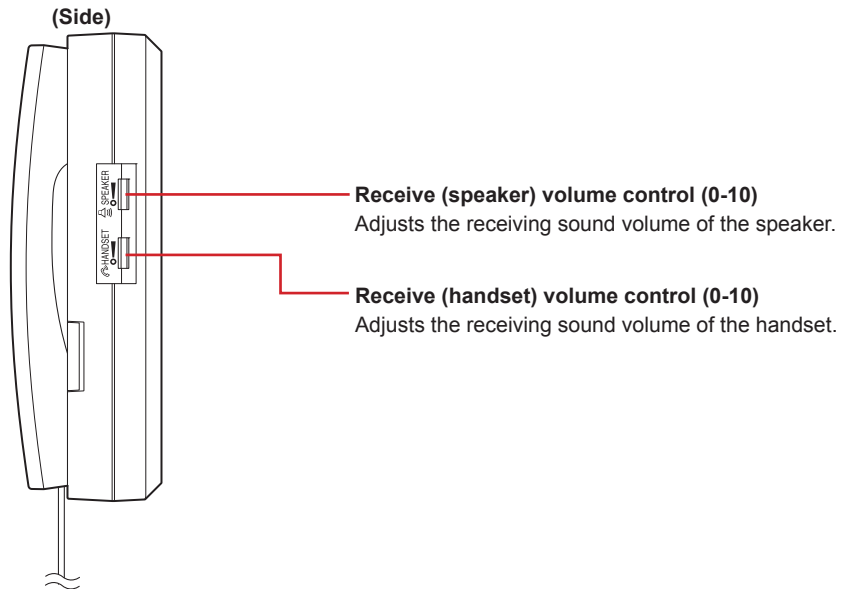
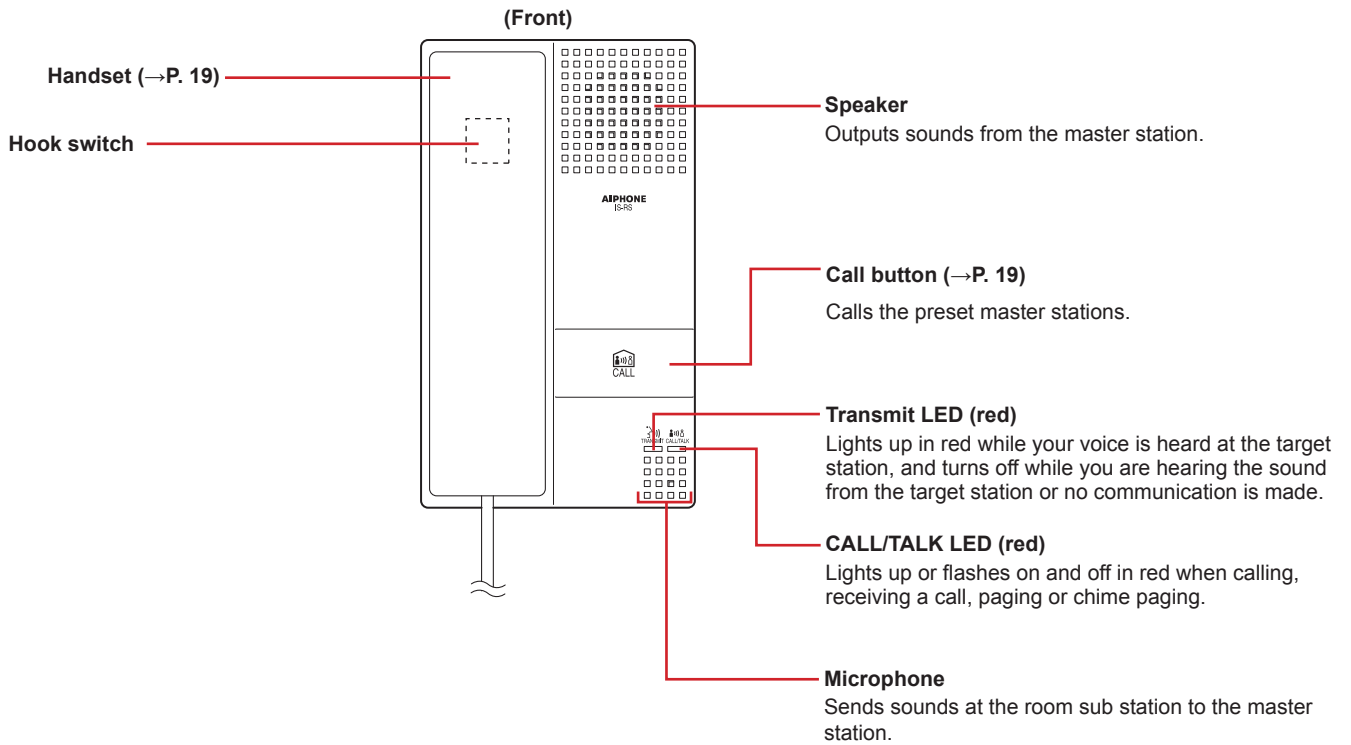

OUTLINE OF OPERATIONS

The following describes the outline of operations you can perform in the system.

Communication

- From a sub station (door station or room sub station), you can call up to 20 preset master stations at the same time.
 - On a master station, you can select a call from the list of incoming calls and answer it.
 - On a master station, the communication method can be selected from the hands-free mode, the press-to-talk mode, or using the handset.
- (→P. 19)

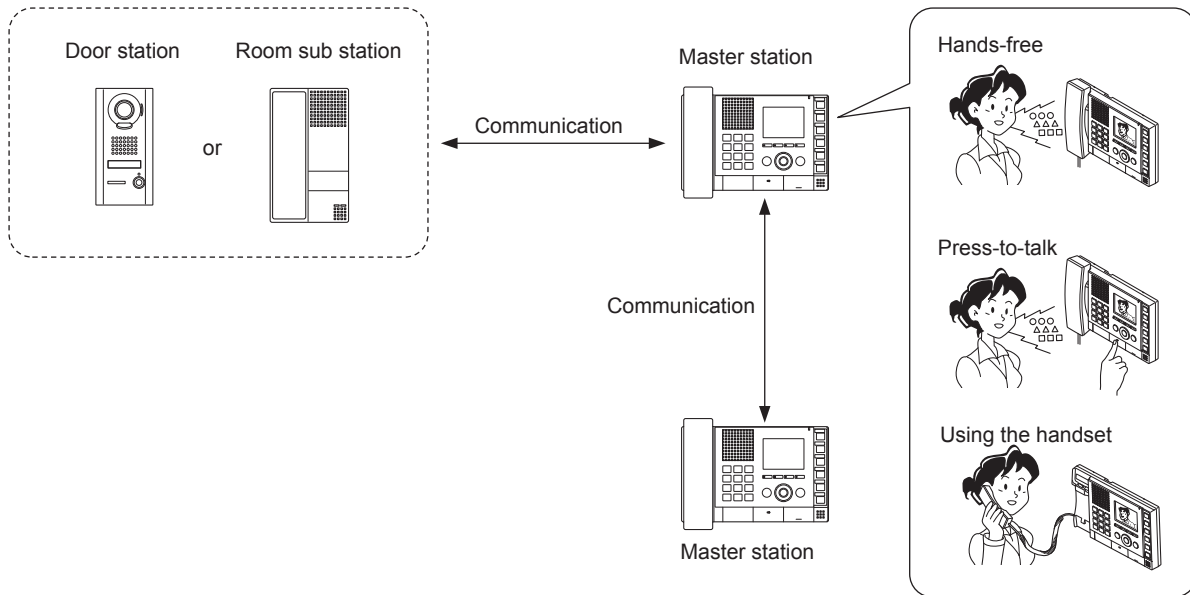

Transferring

When communicating with a received call on a master station, you can transfer it to another master station. (→P. 23)

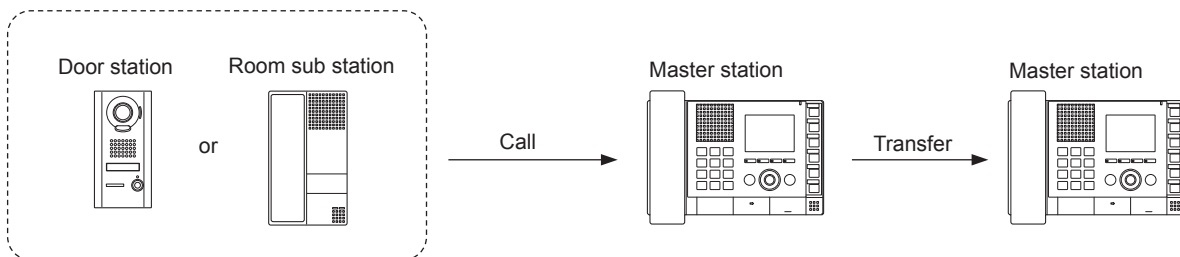

- * You can also make a transfer setting for transferring calls to a designated master station automatically.
- * For a call from another master station, you can transfer it only when you are communicating with it.

Paging

On a master station, you can initiate paging or chime paging to the selected zone(s). All the stations previously registered to the zone(s) receive the paging or chime. (→P. 33)

- * You can also call another master station or a sub station individually by direct voice call. The receiver can reply in the hands-free mode.
- * You can also make paging or chime paging to the registered external speaker(s).

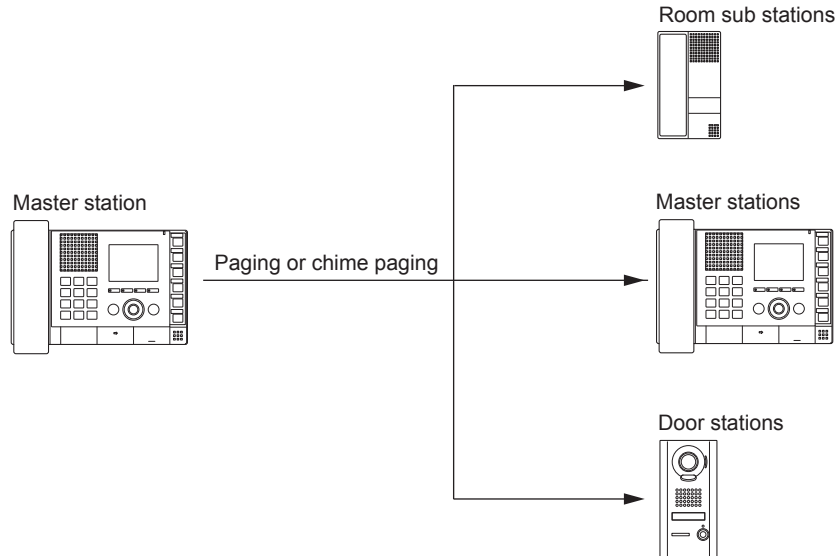

Monitoring

On a master station, you can monitor a sub station.
You can also initiate the scan-monitoring (monitoring multiple preset stations sequentially).
For an audio door station or room sub station, you can monitor sounds only.
(→P. 32)

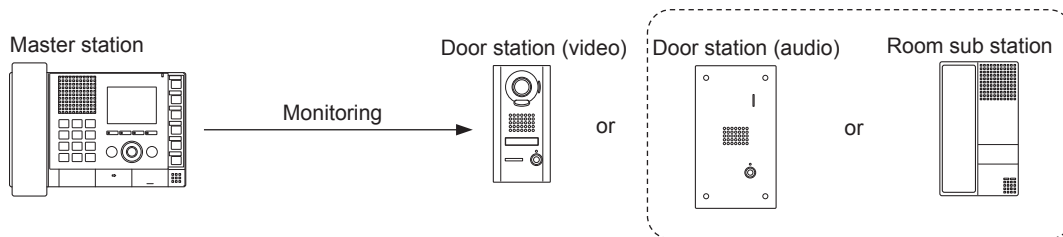

Door release

On a master station, you can unlock the door associated with a sub station call in which a door release device is connected.
(→P. 24)

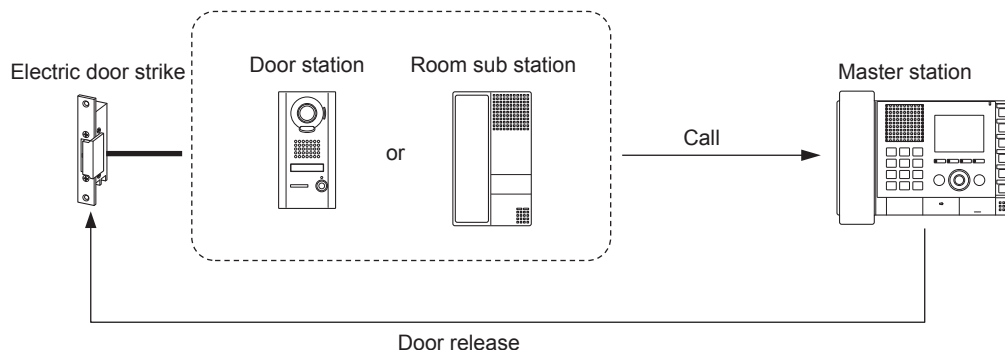

NOTE:

If the door station does not have a camera, you cannot view the image of the visitor. Confirm the visitor securely.

SETTING AND ADJUSTMENT

MASTER STATION SETTINGS AND ADJUSTMENTS

Make the basic and initial settings and adjustments on a master station after the system settings are completed. Make the settings and adjustments to all of the master stations individually.

NOTE: First change the display language for the monitor screen to the language you need. (→ P. 14)

Setting items

You can make the settings and adjustments for the following items. We especially recommend you make all the settings of the items in [INITIAL SETTING] before the first use of the master station.

* [INITIAL SETTING] is available when the master station is in the standby mode.

Item	Sub item	Setting range	Default value	
[BRIGHTNESS]	-	1-10	6	
[TONE VOL]	-	OFF, 1 - 10	6	
[RECEIVE VOL]	-	OFF, 1 - 10	6	
[INITIAL SETTING]	[DOOR CALL TONE]	DOOR CALL: NORMAL	1-6	1
		DOOR CALL: PRIORITY		2
		DOOR CALL: URGENT		3
	[ROOM SUB CALL TONE]	RM SUB CALL: NORMAL	1-6	4
		RM SUB CALL: PRIORITY		5
		RM SUB CALL: URGENT		6
	[COMMUNICATION METHOD]	-	HF (hands-free or press-to-talk) /PTT (press-to-talk)	HF
	[DISPLAY]	[DISPLAY LANGUAGE]	EN (English)	EN
			FR (French)	
			ES (Spanish)	
			NL (Dutch)	
			IT (Italian)	
	DE (German)			
	JP (Japanese)			
	[UN-ANSWERED CALL]	ON/OFF	OFF	
	[LIST ORDER]	ABC/123	123	
	[SPEED DIAL]	[SPEED DIAL1]	(Register a station or zone to each speed dial.)	-
		[SPEED DIAL2]		
		[SPEED DIAL3]		
		[SPEED DIAL4]		
[SPEED DIAL5]				
[SPEED DIAL6]				
[TRANSFER]	[CALL TRANSFER]	ON/OFF	OFF	
	[TRANSFER DESTINA]	(Registering a master station)	-	
	[TRANSFER DELAY]	00-60 (sec.)	00	
	[SCHEDULE TRANSFER]	ON/OFF	OFF	
	[SCHEDULE DESTINA]	(Registering a master station)	-	
	[TELEPHONE TRANSFER]	(Available in the standard (IP) system.)	OFF	
	[SCHEDULE TEL TRANSFER]		OFF	
[PRIVACY]	[PRIVACY MODE]	OFF/1/2	OFF	
	[PRIVACY-2 CALL TONE]	1-6	4	
[INITIALIZATION]	-	NO/YES	NO	

NOTES:

- The monitor will change to the standby mode if approx. one minute has elapsed with no operation on the master station. In that case, the setting results will be saved at the time.
- The above list is a brief overview of the setting items available on the master station. The descriptions, and the style and order of descriptions do not necessarily equate with the actual displays.

Setting the display language

When the master station is started up for the first time, the [DISPLAY LANGUAGE] setting screen appears on the monitor. The display language for the monitor screen is set to English as default. First change it to the language you need as follows.

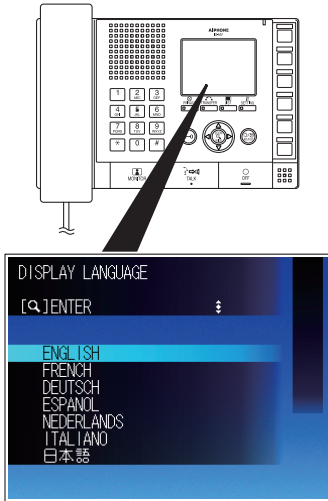

- 1 Press  repeatedly to select the target language (so that it is highlighted).
- 2 Press **ZOOM/WIDE** to decide on the selected one.

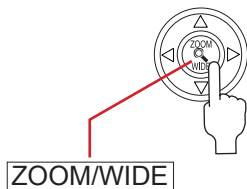

NOTE:

If the [DISPLAY LANGUAGE] setting screen does not appear, press **SETTING**, then select [INITIAL SETTING] → [DISPLAY] → [DISPLAY LANGUAGE], and then select the target language. (→ P. 15-16).

Adjusting screen brightness [BRIGHTNESS]

You can adjust the brightness of the monitor in 10 levels.

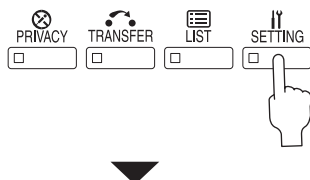

* This adjustment can also be made while receiving a call, communicating or monitoring (when [SETTING] is displayed on the monitor).

- 1 Press **SETTING** in the standby mode.



The setting screen appears.





- 2 Press  repeatedly to select [BRIGHTNESS] (so that it is highlighted).
- 3 Press  repeatedly to change the level.
 - * You can see the change of brightness as you change the value.

Adjusting sound volume [TONE VOL], [RECEIVE VOL]

You can adjust the sound volume of call tone [TONE VOL] and receiving tone [RECEIVE VOL] respectively. The adjusting range is off and 1 to 10.

* This adjustment can also be made while receiving a call, communicating or monitoring (when [SETTING] is displayed on the monitor).

- 1 Press **SETTING** in the standby mode. The setting screen appears.
- 2 Press  repeatedly to select [TONE VOL] or [RECEIVE VOL] you wish to adjust (so that it is highlighted).
- 3 Press  repeatedly to change the level.

- * The call tone sounds in the selected level.
- * If you change the level when communicating, you can check the receiving sound volume of the selected level as it's changed.
- * This icon is displayed when the volume is set to off.

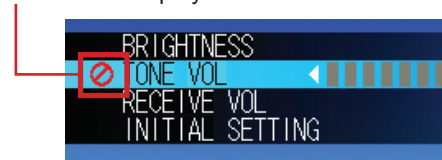

Initial settings [INITIAL SETTING]

Make the initial settings before beginning to use the master station. You can set the following items under [INITIAL SETTING].

001	■ [DOOR CALL TONE]	A
	■ [ROOM SUB CALL TONE]	
	■ [COMMUNICATION METHOD]	B
	■ [DISPLAY]	C
002	■ [SPEED DIAL]	D
	■ [TRANSFER]	E
	■ [PRIVACY]	F
	■ [INITIALIZATION]	G

Basic setting procedure

- 1) Press **SETTING** in the standby mode.

The setting screen appears.

- 2) Press  repeatedly to select [INITIAL SETTING] (so that it is highlighted).

- 3) Press **ZOOM/WIDE** to select.

- 4) Press  repeatedly to select the item you wish to set (so that it is highlighted).

* Pressing  repeatedly turns pages of the list.

(Page 001/002)



(Page 002/002)

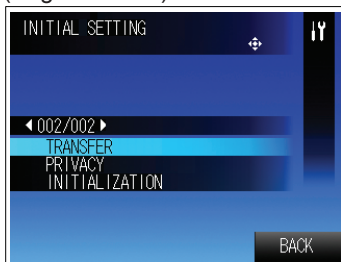

NOTE:

The above display example differs from the actual one.

* When [BACK] is displayed, pressing **SETTING** will return to the setting screen.

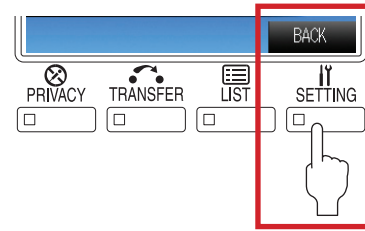

- 5) Press **ZOOM/WIDE** to decide on the selected item.
- 6) Make the settings on the selected item.



(See **A** - **G** below for details on each item.)

(NOTE: Step 1 below corresponds to steps 4) and 5) of "Basic setting procedure" above.)

A Setting the call-in tones [DOOR CALL TONE] and [ROOM SUB CALL TONE]

You can set the call-in tones from door stations [DOOR CALL TONE] and room sub stations [ROOM SUB CALL TONE]. The call-in tones can be set for the priority "Normal", "Priority" and "Urgent" individually.

- 1 Press  repeatedly to select [DOOR CALL TONE] or [ROOM SUB CALL TONE] you wish to set (so that it is highlighted), and then press **ZOOM/WIDE** to decide on the selected item.

- 2 (When setting [DOOR CALL TONE]) :

Press  repeatedly to select [DOOR CALL: NORMAL], [DOOR CALL: PRIORITY] or [DOOR CALL: URGENT] (so that it is highlighted), and then press **ZOOM/WIDE** to decide on the selected one.

- 3 Press  repeatedly to select the desired tone (1 to 6), and then press **ZOOM/WIDE** to decide on the selected one.



* You can check the selected tone by hearing it whenever selected.

- 4 In the same way, set the tone for other priorities, and also for [ROOM SUB CALL TONE].

* Press **SETTING** as "BACK" function to return to the previous screen.

B Setting the communication method for using the microphone and speaker [COMMUNICATION METHOD]

You can select the communication method for using the microphone and speaker between HF (hands-free) and PTT (press-to-talk).

- 1 Press  repeatedly to select [COMMUNICATION METHOD] (so that it is highlighted), and then press **ZOOM/WIDE** to select.
- 2 Press **ZOOM/WIDE**, then press  repeatedly to select [HF] or [PTT] (so that it is highlighted), and then press **ZOOM/WIDE** to decide on the selected one.



[HF]: HF or PTT

[PTT]: PTT only

C Setting the display modes of the monitor [DISPLAY]

You can make the following settings for the display modes.

Sub item	Description	Setting range
[DISPLAY LANGUAGE]	Selects the language for displaying the monitor screen.	EN (English)
		FR (French)
		ES (Spanish)
		NL (Dutch)
		IT (Italian)
		DE (German)
		JP (Japanese)
[UN-ANSWERED CALL]	Sets whether or not to display the record of unanswered incoming call(s) automatically.	ON OFF
[LIST ORDER]	Selects either name or no. to sort the list.	ABC (name)
		123 (no.)



- 1 Press  repeatedly to select [DISPLAY] (so that it is highlighted), and then press **ZOOM/WIDE** to select.
The sub items are displayed.
- 2 Press  repeatedly to select the sub item [DISPLAY LANGUAGE], [UN-ANSWERED CALL] or [LIST ORDER] you wish to set (so that it is highlighted), and then press **ZOOM/WIDE** to decide on the selected one.
- 3 Press  repeatedly to select the desired one, and then press **ZOOM/WIDE** to decide on the selected one.
- 4 In the same way, make the settings for the other sub items.

* Press **SETTING** as "BACK" function to return to the previous screen.

D Registering the desired stations and/or zones to speed dials [SPEED DIAL]

You can register the stations and/or zones you frequently call or select for paging/chime paging to the speed dials. Up to six stations and/or zones can be registered to "SPEED DIAL1" - "SPEED DIAL6". The registered stations and/or zones can be selected by using the corresponding speed dial buttons.

* Only one station or zone can be registered to a speed dial.

- 1 Press  repeatedly to select [SPEED DIAL] (so that it is highlighted), and then press **ZOOM/WIDE** to select.
- 2 (When registering a station or zone to "SPEED DIAL1"): Press  to select [SPEED DIAL1] (so that it is highlighted), and then press **ZOOM/WIDE** to decide on the selected one.

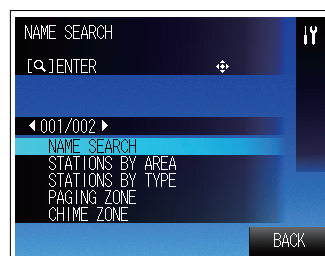

The SEARCH LIST appears.

- 3 Press  to select the desired search item (so that it is highlighted), and then press **ZOOM/WIDE**.
* Refer to pages 26-29 for details about searching for a station or zone.
- 4 Search for the target station or zone.
- 5 Press **ZOOM/WIDE** with the selected station or zone highlighted.
The selected station or zone is registered to [SPEED DIAL1].
* When registering a chime zone, next select a chime source, and then press **ZOOM/WIDE** again.
- 6 In the same way, register other stations and/or zones to [SPEED DIAL2] - [SPEED DIAL6].

NOTE:

To delete the content(s) registered to a speed dial button, select the target speed dial (so that it is highlighted) and then press **PRIVACY** as "DELETE".

E Setting the call transferring [TRANSFER]

You can make the following settings for transferring calls.

Sub item	Description	Setting range
[CALL TRANSFER]	Enables (ON) or disables (OFF) the call transferring.	ON OFF
[TRANSFER DESTINA] (Transfer destination)	(Available when [CALL TRANSFER] is set ON.) Selects a master station as the transfer target.	(Registering a master station)
[TRANSFER DELAY]	(Available when [CALL TRANSFER] is set ON and the target master station is set at [TRANSFER DESTINA].) Sets the time of starting transferring after a call is received.	00-60 (sec.)
[SCHEDULE TRANSFER]	Enables or disables the call transferring to be performed on the schedule preset by the system settings automatically.	ON OFF
[SCHEDULE DESTINA] (Schedule destination)	(Available when [SCHEDULE TRANSFER] is set ON.) Selects a master station as the transfer target on the schedule.	(Registering a master station)
[TELEPHONE TRANSFER]	(Available in the standard (IP) system.)	ON OFF
[SCHEDULE TEL TRANSFER]		ON OFF

- 1 Press  repeatedly to select [TRANSFER] (so that it is highlighted), and then press **ZOOM/WIDE** to select.

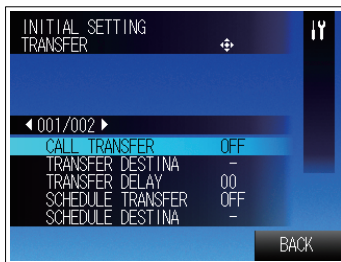
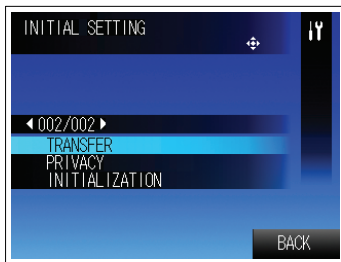

The sub items are displayed.

- * The sub items can also be displayed by pressing **TRANSFER** in the standby mode.

NOTE:

The above display example differs from the actual one.

- 2 Press  repeatedly to select the target sub item (so that it is highlighted), and then press **ZOOM/WIDE** to select.

- 3 Make the settings on each sub item as follows.

[CALL TRANSFER]:

Press  repeatedly to select ON or OFF, and then press **ZOOM/WIDE** to decide on the selected one.

[TRANSFER DESTINA] (Transfer destination):

- * This setting is available only when [CALL TRANSFER] is ON.

Press  repeatedly to select the target master station (so that it is highlighted), and then press **ZOOM/WIDE**.

- * The LED on **TRANSFER** lights up (red) when [CALL TRANSFER] is set ON and the target master station is set at [TRANSFER DESTINA].

[TRANSFER DELAY]:

- * This setting is available only when [CALL TRANSFER] is set ON and the target master station is set at [TRANSFER DESTINA].

Press  repeatedly to set the delay time, and then press **ZOOM/WIDE** to select.

- * If the delay time is set to "00", a call will be transferred to the target station directly.

[SCHEDULE TRANSFER]:

Press  repeatedly to select ON or OFF, and then press **ZOOM/WIDE** to decide on the selected one.

[SCHEDULE DESTINA] (Schedule destination):

- * This setting is available only when [SCHEDULE TRANSFER] is ON.

Press  to select the target master station (so that it is highlighted), and then press **ZOOM/WIDE**.

- * Press **SETTING** as "BACK" function to return to the previous screen.

F Setting the PRIVACY function [PRIVACY]

Setting of the PRIVACY function is available when called from another master station.

When the PRIVACY MODE is activated, the microphone turns off and you will not be heard by the caller.

Sub item	Description	Setting range
[PRIVACY MODE]	Sets whether or not to activate the PRIVACY function. To activate the PRIVACY function, select the PRIVACY MODE 1 or 2.	(PRIVACY MODE) 1: The microphone is off (mute).
		(PRIVACY MODE) 2: The microphone is off (mute) and the caller and you are notified by a tone when you receive the call that you are in the PRIVACY MODE.
		OFF: The microphone is on.
[PRIVACY-2 CALL TONE]	(Available when (PRIVACY MODE) 2 is selected.) Selects the call tone from 6 types.	1-6

- 1 Press  repeatedly to select [PRIVACY] (so that it is highlighted), and then press **ZOOM/WIDE** to select.

The sub items are displayed.

- * The sub items can also be displayed by pressing **PRIVACY** in the standby mode.

- 2 Press  repeatedly to select the sub item [PRIVACY MODE] or [PRIVACY-2 CALL TONE] you wish to set (so that it is highlighted), and then press **ZOOM/WIDE** to decide on the selected one.

- 3 Make the settings on each sub item as follows.



[PRIVACY MODE]:

Press  repeatedly to select the desired mode (so that it is highlighted), and then press **ZOOM/WIDE** to decide on the selected one.

- * When (PRIVACY MODE) 1 or (PRIVACY MODE) 2 is selected, the LED on **PRIVACY** lights up (red).

[PRIVACY-2 CALL TONE]:

- * This setting is available only when [PRIVACY MODE] is set to (PRIVACY MODE) 2.

Press  repeatedly to select the desired call tone, and then press **ZOOM/WIDE** to decide on the selected one.

- * You can check the selected tone by hearing it whenever selected.

G Initializing the set contents [INITIALIZATION]

You can reset all the set contents to default.

- 1 Press  repeatedly to select [INITIALIZATION] (so that it is highlighted), and then press **ZOOM/WIDE** to select.

"RETURN TO DEFAULT ?" is displayed.

- 2 Press **ZOOM/WIDE** to continue the initialization procedure.

- 3 Press  repeatedly to select [YES] (so that it is highlighted) to perform initializing, and then press **ZOOM/WIDE** to select.

- * Select [NO] if you will cancel initialization.

NOTE:

If you have repositioned the master station, initialize it to clear the speed dial settings etc., and make the settings again.

USING THE SYSTEM

RECEIVING AND ANSWERING A CALL ON THE MASTER STATION

The following describes the communication method using this system.

Receiving a call

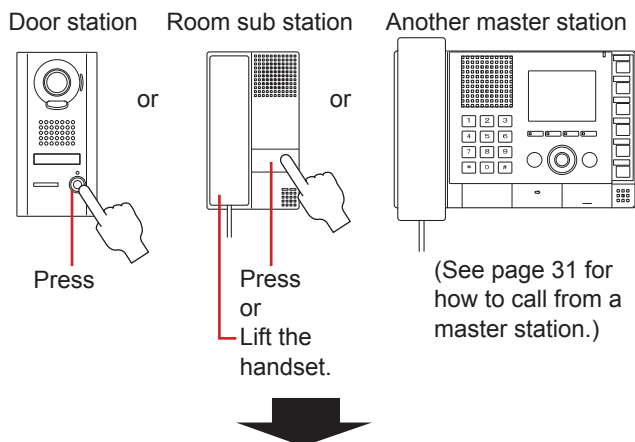

1 The call tone rings, and the corresponding display appears.

* The call tone from a sub station differs from the setting. (→P. 15)

e.g.) When called from a video door station

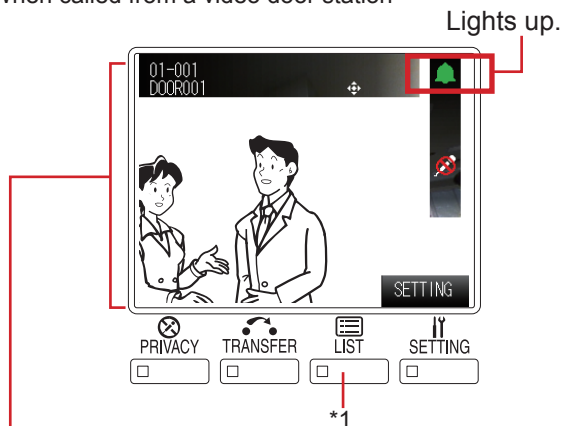

The station no., station name and video image at the calling station (following the station type image) are displayed.

- * It may take long until a video image appears on the monitor.
- * When an audio door station, room sub station or another master station calls in, the station type image is displayed. (The image differs from the calling station type.)
- * An incoming call from another master station will be a direct voice call. (However, when the PRIVACY MODE is set to "2", you will be notified of an incoming call by the display information and call tone.)
- * When you answer a call, the call tone of subsequent incoming calls should be muted until you conclude the first call.

*1: LIST

Press to display the list of stations when two or more calls have arrived. You can select the desired one and start communicating with the caller. (→P. 20)

Answering a call

The maximum duration of communication is preset in the System setting. (It can be set to a maximum of 10 minutes.)

1 Answer the call in one of the following ways.

Communication in the hands-free mode

(Available when "COMMUNICATION METHOD" is set to "HF" in the "INITIAL SETTING")

<When called in from a sub station>

1) Press TALK momentarily.

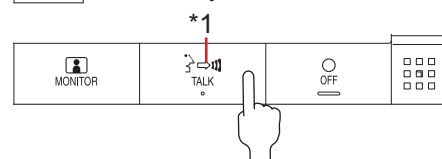

After a beep, you can communicate in the hands-free mode.

*1: When talking: ➡ (Lit)
When listening to the caller: ⇨ (Off)

2) When you have finished the communication, press OFF.

Communication will end.

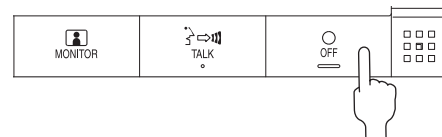

* You can communicate in the press-to-talk mode by the following operation even when "HF" is set (e.g., when it is noisy around you).

- Press and hold TALK for a few seconds while being called. (Beeps twice and [PRIVACY] disappears from the display.)
- Press and hold TALK for more than one second while communicating. (Beeps once and [PRIVACY] disappears from the display.)

<When you received a direct voice call from another master station>

You can talk back to it. If you press and hold TALK for more than one second, it changes to the press-to-talk mode. (Beeps once and [PRIVACY] disappears from the display.)

(Continued on next page.)

■ Communication in the press-to-talk mode
(Available when "COMMUNICATION METHOD" is set to "PTT" in the "INITIAL SETTING")

<When called in from a sub station>

- 1) Press **TALK** momentarily.

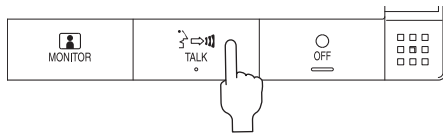

After a beep, you can communicate in the press-to-talk mode.

- 2) Press and hold **TALK** to talk and release to listen to the caller.

(When talking)

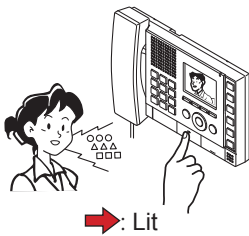

(When listening to the caller)

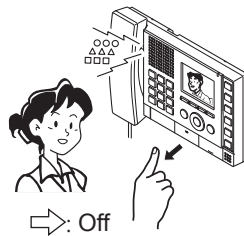

- 3) When you have finished the communication, press **OFF**.

Communication will end.

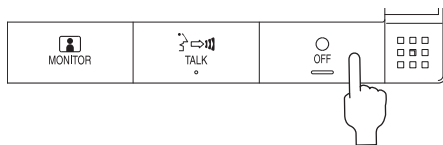

<When you received a direct voice call from another master station>

Press and hold **TALK** to talk with and release to listen to the caller.

■ Communication by using the handset

<In the hands-free mode>

- 1) Lift the handset and you can communicate with the handset.

* You can also communicate in the press-to-talk mode by pressing and holding **TALK**.

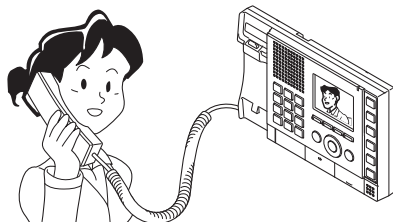

- 2) When you have finished the communication, put the handset on the hook.
Communication will end.

<In the press-to-talk mode>

You can communicate in the press-to-talk mode by pressing and holding **TALK** even when you are communicating with the handset.

NOTE:

Communication will end automatically according to the set communication time.

When two or more calls have arrived

- 1) Select a call to answer by following the steps 1) and 2) below.

- 1) Press **LIST**.

The list of calling sub stations is displayed.

- 2) Press  repeatedly so that the station no. (and/or name) of the sub station you will select is highlighted.

* Calls from other master stations are not displayed in the list.

- 2) Press **TALK**, **ZOOM/WIDE** or lift the handset*¹, and you can answer the call.

* When the communication is finished, subsequent incoming calls ring.

* If you select another sub station while communicating, the current communication is forcibly stopped, and then you can answer the selected station with direct voice call after a beep.

*¹: When you are receiving a direct voice call from another master station, lifting the handset will not enable you to communicate with the selected sub station. In that case, press **TALK** or **ZOOM/WIDE** with the handset lifted.

About the priority

When receiving two or more functions (communication, calling, paging, monitoring, etc.) at the same time, depending on the priority setting, the order of priority for them is as follows.

Priority	Setting	Function
1 (high)	[URGENT], [BROADCAST]* ²	Communication, calling, paging, chime paging.
2	[PRIORITY]	
3	[NORMAL]	
4 (low)	-	Monitoring, scan-monitoring

* Earlier call has priority over later call if the priority setting is the same. When the communication path is occupied, it is notified by a sound.

* Communication takes priority over calling. However, when a call with higher priority comes in, the communication will be forcibly stopped.

* With a master station, you can select the desired one from the list of currently received calls, etc.

*²: [BROADCAST]:

This can be selected only when you perform paging. When [BROADCAST] is selected, you can perform paging while interrupting all the other communications of lower priority. In that case, no receiver can answer you.

NOTE:

When communication is stopped by receiving a higher priority operation, a notice sound rings.

Viewing video images of the caller (at a video door station)

You can view video images of the caller when receiving a call from, communicating with or monitoring a video door station. The video images can be adjusted as necessary by using the following functions on the master station.

■ Switching Zoom/Wide

The display mode on the monitor can be switched between zoom and wide by each press of **ZOOM/WIDE**.

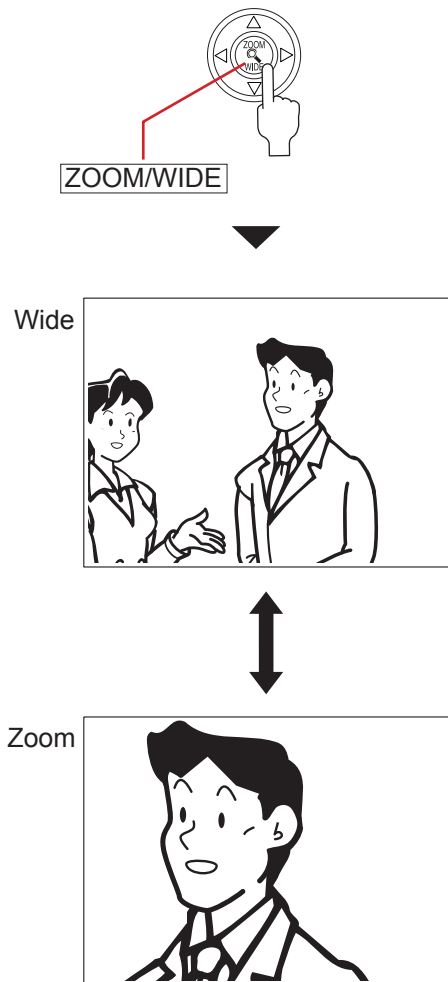

NOTES:

- The preset position of zoom image is set in the System setting on a PC.
- When the display mode switches from wide to zoom, the zoom image from the preset position is displayed.
- Depending on the properties of the video door station camera, the wide image may appear more distorted than the zoom image but this is not a malfunction.
- In the zoom mode, the image can be moved from right to left or up and down.

■ Pan & Tilt

When a zoom image is displayed, pressing  moves the image as shown below.

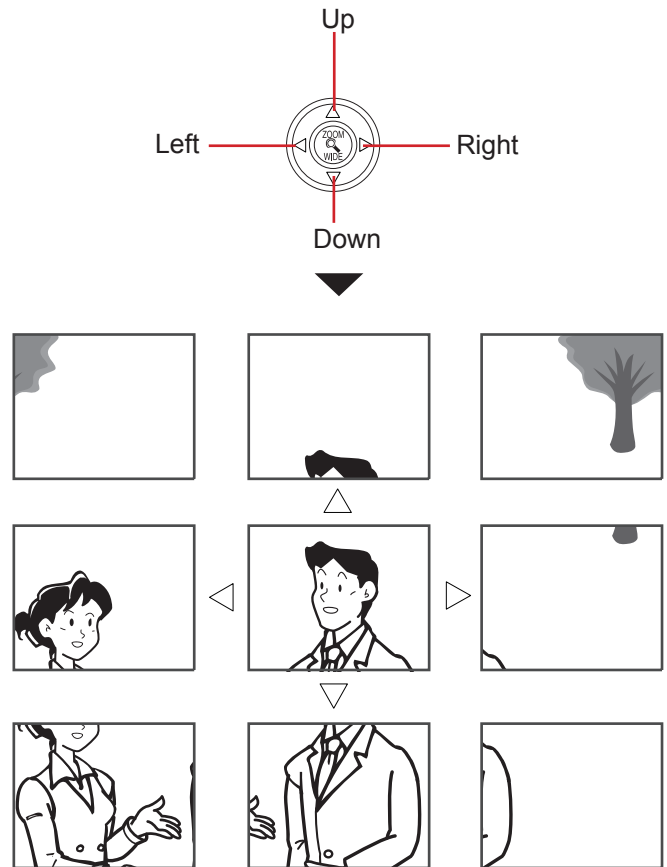

NOTES:

- The image range of the zoom mode and wide mode differs. The edge of wide image will not be displayed with the zoom mode.
- At night, the object image may be blurred and less-visible when moving the image from right to left or up and down because illumination to the object is reduced. The same applies to a moving object.

■ Adjusting images

If the image on the monitor is difficult to see, you can adjust the image.

1 Press **ADJUST** when the image is difficult to see.

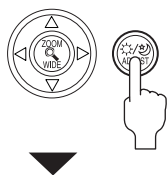

The backlight or night sensitivity is automatically adjusted.

- * The discrimination between day and night is performed automatically by the door station.
- * The adjustment result may vary depending on the System setting on a PC.

<Day>



[Before adjustment]



[After adjustment]

<Night>



[Before adjustment]



[After adjustment]

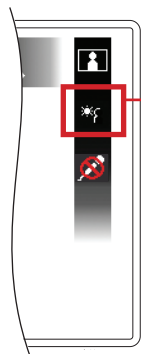

Shows which adjustment is being made.

 : Backlight adjustment

 : Night sensitivity adjustment

To restore the image before adjustment

Press **ADJUST** again.

The icon is cleared and the image before adjustment is restored.

NOTE:

Pressing **ADJUST** at night may make visitors' faces easier to see, but may also make moving objects more difficult to see.

Transferring to another master station

You can transfer a call received from a sub station to another master station while communicating with it (communication transferring), as well as setting calls to be automatically transferred in the "INITIAL SETTING".

* For a call from another master station, you can transfer it only when you are communicating with it.

■ Communication transferring

1 Receive a call and communicate with it. (→P. 19)

2 Press **TRANSFER**.

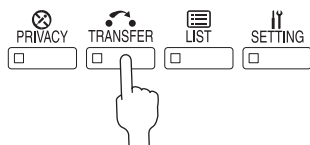

3 Press  to select the master station to which you want to transfer the call (so that it is highlighted) from the list.

4 Press **TALK** or **ZOOM/WIDE**.

Appears while the transfer is being performed.

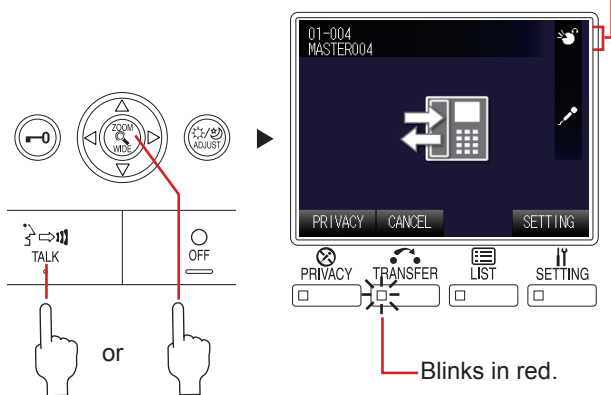

* While transferring, a sound rings at the source station to indicate a transfer.

5 Press **OFF** to enable the communication between the station that called you and the transfer target station.

■ Call transferring

You can transfer a call to the designated master station automatically (without answering it) by the "TRANSFER" settings in the "INITIAL SETTING". (→P. 17)

* This function is useful when you are absent or you cannot receive and answer a call.

The following settings can be made.

- ① Transferring a call to the designated master station automatically (→P. 17 [CALL TRANSFER], [TRANSFER DESTINA])
- ② Setting the delay time of triggering transferring after a call is received (→P. 17 [TRANSFER DELAY])
- ③ Setting a schedule for call transferring in the System setting on a PC (→P. 17 [SCHEDULE TRANSFER], [SCHEDULE DESTINA])

* When both ① and ③ are set, ③ takes priority.

Door release

You can release the door lock while being called from, communicating with, or monitoring a sub station if a door release device is connected to the station.

Press **[R-0]** while being called from, communicating with, or monitoring the sub station.

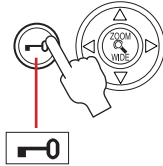

The door lock is released for the time set in the System setting on a PC.

* If the set release time is "0", it can be released while the button is pressed and held.

CAUTION:

Be sure to confirm the visitor securely before releasing the door if the sub station has no camera.

NOTE:

This function is disabled during scan-monitoring. (→ P. 32)

Using the PRIVACY function

The PRIVACY function of a master station prevents you from being heard by other master stations that call you.

To activate the PRIVACY function

Set the PRIVACY MODE to "1" or "2" in the "INITIAL SETTING". If you will not use the PRIVACY MODE, set it to "OFF". (→P. 18)

■ While receiving a call

• When the PRIVACY function is activated

The microphone of your master station is muted, so the sounds at your side are not heard by the caller.

• When the PRIVACY function is off

The microphone of your master station is enabled, so the sounds at your side are heard by the caller.

■ To communicate with the caller

• When the PRIVACY function is activated

Press **[TALK]** or lift the handset, and the microphone is enabled. Then you can communicate with the caller.

• When the PRIVACY function is off

You can communicate with the caller without pressing **[TALK]** or lifting the handset.

* To mute the microphone temporarily:

Press and hold **[PRIVACY]**, and the microphone is muted. Release **[PRIVACY]** to enable the microphone.

The status of master station depending on the PRIVACY MODE

PRIVACY MODE	LED	When receiving a call from another master station	When communicating with a sub station
1	Lit	<ul style="list-style-type: none"> The microphone is muted. When you press [TALK] or lift the handset to answer the call, the microphone is enabled. 	<ul style="list-style-type: none"> Microphone is enabled. The microphone is muted while pressing [PRIVACY].
2	Lit	<ul style="list-style-type: none"> The microphone is muted. When you receive a call from a master station, the caller and you are notified by a tone that you are in the PRIVACY MODE. When you press [TALK] or lift the handset to answer the call, the microphone is enabled. 	
OFF	Off	<ul style="list-style-type: none"> The microphone is enabled. Communication starts when a direct voice call arrives from a master station. The microphone is muted while pressing [PRIVACY]. 	

NOTE:

When "COMMUNICATION METHOD" is set to "PTT" (press-to-talk mode) in the "INITIAL SETTING", you do not have to activate the PRIVACY function.

PERFORMING CALLING, MONITORING, PAGING AND CHIME PAGING ON THE MASTER STATION

The following describes how to operate the master station to perform calling, monitoring, paging and chime paging.

Searching for a station or zone

Read this section before you perform calling, monitoring, paging or chime paging for the first time to learn how to search for stations or zones. The search can be performed in the following search methods by using the search items, dial keys or speed dial buttons to suit your needs.

Searching for a station or zone from the list (→P. 27)

Search items: **A**, **B**, **C**, **D**, **E**

Searching for a station or zone from the placed call or received call list (→P. 30)

Search items: **F**, **G**

Searching for a station or zone by number using the dial keys (→P. 29)

Selecting a station or zone by using the speed dial buttons (→P. 30)

Basic procedure for selecting the search items

The search items **A** – **G** can be selected from the standby mode or the SEARCH LIST.

* The items **A** and **B** can be selected from both the standby mode and the SEARCH LIST.

[In the standby mode]

Press the corresponding button on  to select the target search item **A**, **B**, **F** or **G** by following the key map.

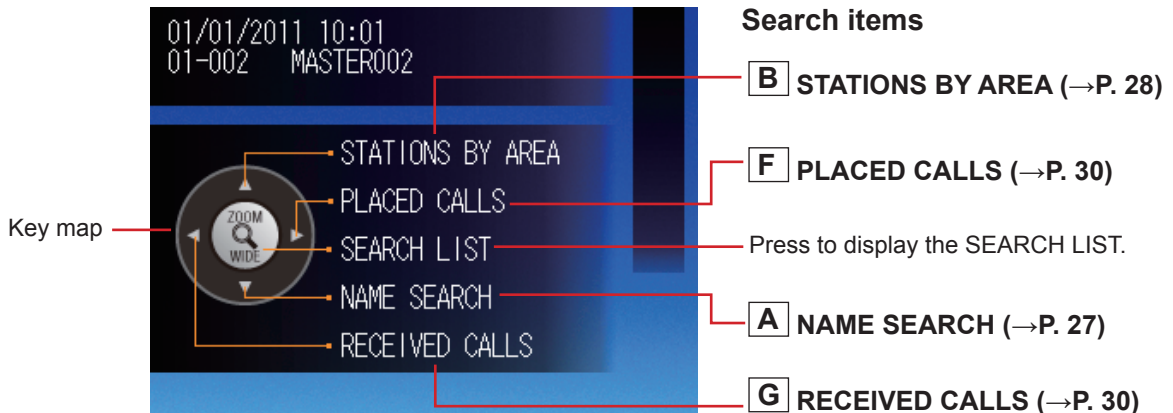
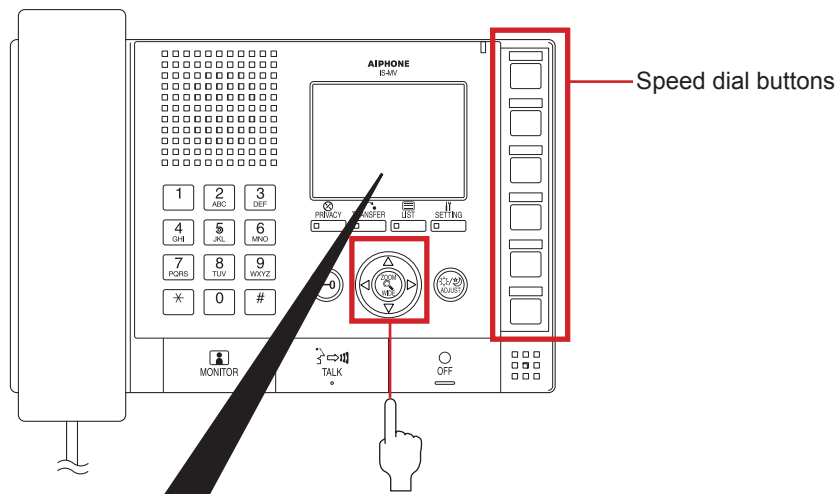

[In the SEARCH LIST]

- 1** Press **LIST** or **ZOOM/WIDE** in the standby mode.
The search items are shown in the SEARCH LIST.

- 2** Press  repeatedly to select the target search item **A** to **E** (so that it is highlighted).

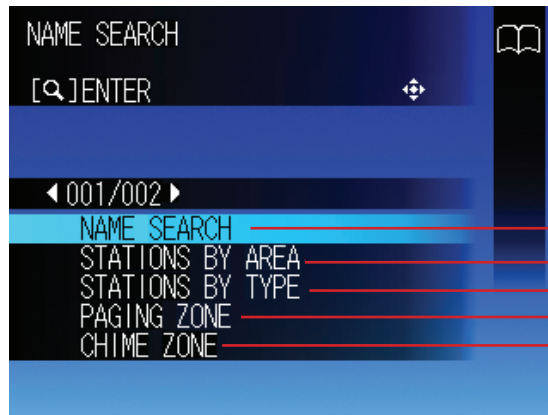
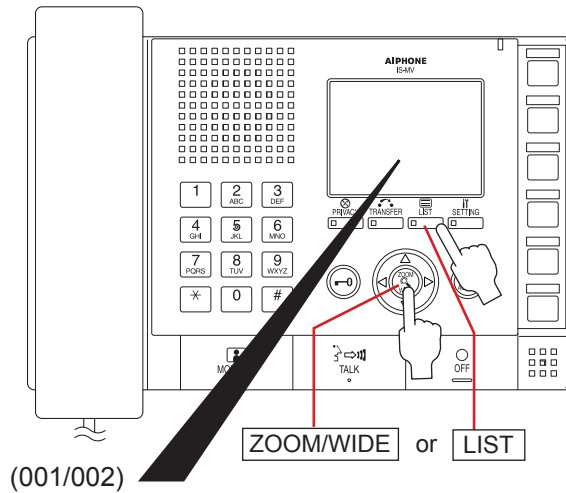

Search items

- A** NAME SEARCH (→P. 27)
- B** STATIONS BY AREA (→P. 28)
- C** STATIONS BY TYPE (→P. 28)
- D** PAGING ZONE (→P. 29)
- E** CHIME ZONE (→P. 29)

* "REMOTE SITE" on page 002/002 of the SEARCH LIST is not available in this system. (This is used for the standard (IP) system.)

- 3** Press **ZOOM/WIDE** to decide on the selected one.

Searching for a station or zone from the list

A Searching for a station or zone by entering the name [NAME SEARCH]

- 1 Select [NAME SEARCH] either in the standby mode (→P. 25) or the SEARCH LIST (→P. 26).
- 2 Enter a name by using the dial keys. (→P. 35)

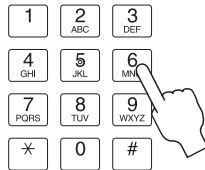

e.g.)
When searching for "MASTER 004";
Press the dial keys as follows.

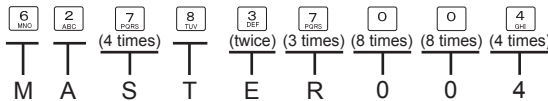

The entered characters are displayed here.

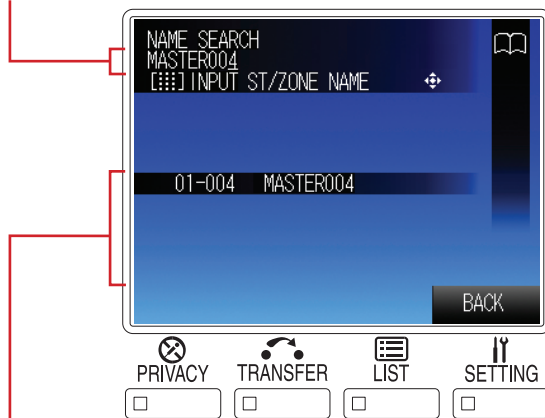

All the station and/or zone names that include the entered characters are displayed in the list.

* The search is narrowed down whenever a character is added.

NOTE:

You can also select a station from the list by using  after you select [NAME SEARCH] in step 1.



To delete the just entered character:

Press .



To enter the same characters or characters on the same dial key sequentially:

(e.g.: To enter "AB")

1. Enter "A". (Press the dial  key once.)
2. Press .

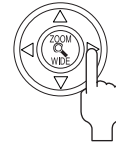

3. Enter "B". (Press the dial  key twice.)

- 3 Press  to select the target station or zone (so that it is highlighted) from the list.

* You can select up to 5 stations and/or zones if [ADD/RMV] is displayed on the screen. (See below.)

- 4 Start calling (talking), monitoring or paging by following the procedure for the corresponding performance. (→P. 31-33)

To select two or more stations and/or zones from the list: (When **ADD/RMV** (Add/Remove) is displayed on the screen)

- 1) Press **LIST** as **ADD/RMV** with the target station or zone highlighted.

The station or zone is checked.

* Press **LIST** as **ADD/RMV** again to clear the check.

- 2) Repeat step 1) to select more stations and/or zones.

* You can select up to 5 stations and/or zones. To select 5 stations and/or zones, after checking 4 stations and/or zones, select the 5th one so that it is highlighted. (The 5th station or zone is not checked.)

B Searching for a station by designating an area
[STATIONS BY AREA]

1 Select [STATIONS BY AREA] either in the standby mode (→P. 25) or the SEARCH LIST. (→P. 26)

2 Press  to select the target area from the list (so that it is highlighted), and then press **ZOOM/WIDE** to select.

All the stations in the area are displayed in the list.

3 Press  to select the target station (so that it is highlighted).

* You can select up to 5 stations. (→P. 27)

4 Start calling (talking), monitoring or paging by following the procedure for the corresponding performance. (→P. 31-33)

C Searching for a station by designating a station type
[STATIONS BY TYPE]

1 Select [STATIONS BY TYPE] from the SEARCH LIST. (→P. 26)

All the station types are displayed in the list.

2 Press  to select the target station type from the list (so that it is highlighted), and then press **ZOOM/WIDE** to select.

All the stations of the selected type are displayed in the list.

3 Press  to select the target station (so that it is highlighted).

* You can select up to 5 stations. (→P. 27)

4 Start calling (talking), monitoring or paging by following the procedure for the corresponding performance. (→P. 31-33)

D Searching for a paging zone from the list [PAGING ZONE]

- 1 Select [PAGING ZONE] from the SEARCH LIST. (→P. 26)
All the registered paging zones are displayed in the list.
- 2 Press  to select the target zone (so that it is highlighted).
* You can select up to 5 zones. (→P. 27)
- 3 Start paging by following the procedure for paging. (→P. 33)

E Searching for a chime zone from the list [CHIME ZONE]

- 1 Select [CHIME ZONE] from the SEARCH LIST. (→P. 26)
All the registered chime zones are displayed in the list.
- 2 Press  to select the target zone (so that it is highlighted).
* You can select up to 5 zones. (→P. 27)
- 3 Start chime paging by following the procedure for chime paging. (→P. 33)

Searching for a station or zone by number using the dial keys

- 1 Enter the number of the station or zone you want to search for by using the dial keys in the standby mode.

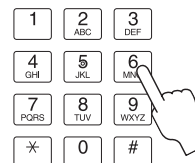

The entered numbers are displayed, and all the stations or zones that include the entered number are displayed in the list.

* The search is narrowed down whenever a figure is added.



- 2 Press  to select the target station and/or zone (so that it is highlighted).
* You can select up to 5 stations and/or zones. (→P. 27)
- 3 Start calling (talking), monitoring or paging by following the procedure for the corresponding performance. (→P. 31-33)

Searching for a station or zone from the placed call or received call list



You can search for a station or zone from the most recent 20 items of the call and/or (chime) paging record or reception record.

* The items are displayed in the list in chronological order.

F Searching for a station or zone from the call and/or (chime) paging record list [PLACED CALLS]

- 1 Press  to select [PLACED CALLS] in the standby mode. (→P. 25)
Up to 20 items (target stations or zones) of the most recent call and/or (chime) paging you performed are displayed in the list.
- 2 Press  to select the target station or zone (so that it is highlighted).
- 3 Start calling (talking), monitoring, paging or chime paging by following the procedure for the corresponding performance. (→P. 31-33)

G Searching for a station from the reception record list [RECEIVED CALLS]

- 1 Press  to select [RECEIVED CALLS] in the standby mode. (→P. 25)
Up to 20 items (stations) of the most recent call and/or paging you received are displayed in the list.
- 2 Press  to select the target station (so that it is highlighted).
- 3 Start calling (talking) or monitoring by following the procedure for the corresponding performance. (→P. 31, 32)

Selecting a station or zone by using the speed dial buttons

Select a station or zone registered to one of the speed dials (1 to 6) simply by pressing the corresponding speed dial button.

- 1 Press the speed dial button to which the target station or zone is registered (highlighted).

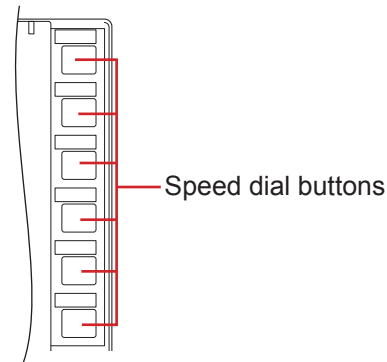

- 2 Start calling (talking), monitoring, paging or chime paging by following the procedure for the corresponding performance. (→P. 31-33)

Calling another station (direct voice call)

Follow the steps below to call a desired door station, room sub station or master station.

- 1 Search for and select the station you want to call (so that it is highlighted) in one of the search methods. (→P. 25-30)

Refer to the on-screen instructions:

Be sure to make operations by checking the information on the upper part of the monitor. The next operations you can perform are displayed.

e.g.)

[] TALK ... You can start talking by pressing [TALK] or lifting the handset.

* If you will not set the priority, it is set to "Normal".

[] MONI ... You can start monitoring by pressing [MONITOR].

[] PR (or PRIORITY) You can proceed to the priority setting mode by pressing [ZOOM/WIDE].

- 2 To set the priority, press [ZOOM/WIDE], and then press  to select the target priority (so that it is highlighted).

* If you will not set the priority, skip this step and press [TALK] or lift the handset. You can start calling (talking).

- 3 Press [TALK] or [ZOOM/WIDE] or lift the handset to start calling (talking).

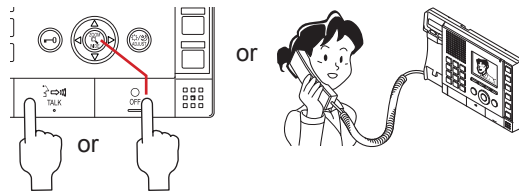

When a tone rings, your voice is heard at the target station and you can also hear sounds at the target station. (Direct voice call)

The receiver can answer the call without pressing any button or lifting the handset. (Talk back)

* If the target station is a master station, the response of it differs from the PRIVACY MODE setting on the target station. (See the table below.)

PRIVACY MODE setting on the target master station	Response
OFF	Your voice is heard at the target station and you can also hear sounds at the target station.
1	Communication is enabled when the receiver presses [TALK] or lifts the handset. Otherwise you can hear no sound from the target station.
2	When the target station receives your call, a tone notifies you that the target station is in the (PRIVACY MODE) 2. Communication is enabled when the receiver presses [TALK] or lifts the handset. Otherwise you can hear no sound from the target station. * You can adjust the volume of call tone from [RECEIVE VOL] by pressing [SETTING].

- 4 Press [OFF] or hang up the handset to finish communicating.

Monitoring

You can monitor a sub station or multiple sub stations sequentially (scan-monitoring) with a master station.

- * When monitoring a video door station, you can view the image at the station and hear the sound. When monitoring an audio door station or room sub station, you can only hear the sound at the station.

■ Monitoring

- 1 Search for and select the sub station you want to monitor (so that it is highlighted) in one of the search methods. (→P. 25-30)

NOTE:

You cannot monitor a master station.

- 2 Press **MONITOR** (when "[CAM] MONI" is displayed).

You can hear the sound and if the station has a camera, you can also view the image.

- 3 Press **OFF** to finish monitoring.

NOTES:

- If the selected station is being used (calling, communicating, being monitored, etc.), you cannot monitor the station.
- If you press **TALK** or lift the handset while monitoring, the communication mode starts with the station after a tone.
- During video monitoring, you can switch Zoom/Wide, make Pan & Tilt control and adjust images on the monitor. (→P. 21-22)

To switch to scan-monitoring

Press **MONITOR** during monitoring.

- * If the station being monitored is a preset one for scan-monitoring, the scan-monitoring starts from the subsequent station in the scan-monitoring order.
- * If the station being monitored is not a preset one for scan-monitoring, the scan-monitoring starts from the first station in the scan-monitoring order.

■ Scan-monitoring

You can monitor the preset stations (up to 20 door stations and/or room sub stations) sequentially, each for the set duration.

- * The stations should be preset in the System setting on a PC.

- 1 Press **MONITOR** in the standby mode.

The stations set for scan-monitoring are monitored sequentially, each for the set duration.

- * If the scan-monitoring lasts 10 minutes, the backlight of the master station monitor will be turned off.

Pressing any key will turn on the backlight again.

- * If the scan-monitoring target station is only one, the scan-monitoring ends after a lapse of approx. 11 minutes.

- 2 Press **OFF** to stop scan-monitoring.

To monitor only the desired station continuously:

Press **MONITOR** when the target station is being monitored during scan-monitoring.

- * Press **MONITOR** again to restart the scan-monitoring.

NOTES:

- Pressing **TALK** is invalid during scan-monitoring.
- If the handset is lifted during scan-monitoring, the scan-monitoring is continued and sounds at the target station can be heard from the handset, and when the handset is hung up or **OFF** is pressed, the scan-monitoring ends.
- If the master station receives a call during scan-monitoring, the scan-monitoring ends automatically.
- If one of the preset stations is being used (calling, communicating, being monitored, etc.) during the scan-monitoring, it will be skipped.
- During the scan-monitoring, the Zoom/Wide, Pan & Tilt, door release and image adjusting functions are disabled. (The camera is fixed in the Wide mode.)

Viewing video images at the target station

When you are receiving a call from, communicating with or monitoring a video door station, you can view video images at the target station.

Use the following functions on the master station to control video images as you prefer. (→P. 21-22)

- Switching Zoom/Wide
- Pan & Tilt
- Adjusting images

NOTE:

Video images cannot be controlled during scan-monitoring.

Paging

The system allows you to page (transmit an announcement) the selected zone(s) and/or station(s) simultaneously.

NOTE:

If you use zones, register zones in the System setting on a PC in advance.

- 1 Search for and select the zone you want to page (so that it is highlighted) in one of the search methods. (→P. 25-30)

* You can select up to 5 zones and/or stations for paging. (→P. 27)

- 2 To set the priority (when “[Q] PRIORITY” is displayed), press **ZOOM/WIDE**, and then press  to select the target priority (so that it is highlighted).

* If you will not set the priority, skip this step and press **TALK** or lift the handset. You can start paging after a tone.

- 3 Press **TALK** or **ZOOM/WIDE**, or lift the handset (when “[Q] PAGE” is displayed).

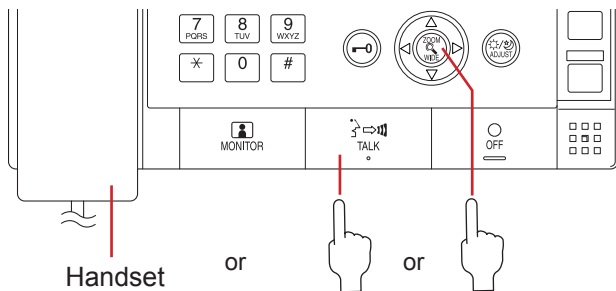

- 4 After a tone rings, start paging.
 - 5 A receiver can answer it and communicate with you by pressing **TALK** or lifting the handset, or pressing the external call button*1.
- * When the priority is set to "BROADCAST", no receiver can answer the paging. The paging will be heard in priority to any other performances (of lower priority) including ongoing communications between stations. (→P. 20)
- 6 When you have finished paging, press **OFF** or hang up the handset.

*1: Connected to a room sub station and the necessary setting should be made in the System setting on a PC. (Be careful not to press the call button on a room sub station by mistake.)

Chime paging

The system allows you to make chime paging (transmit a chime) to all the stations in the designated zone(s) simultaneously.

NOTE:

If you use zones, register zones in the System setting on a PC in advance.

- 1 Search for and select the zone you want to make chime paging (so that it is highlighted) in one of the search methods. (→P. 29, 30)

* You can select up to 5 zones for chime paging. (→P. 27)

* If you have selected the target zone (so that it is highlighted) by using a speed dial button, then skip to step 4.

- 2 Press **TALK** or **ZOOM/WIDE** (when “[Q] PLAY SOUND” is displayed).

- 3 Press  to select the sound source of chime from the list (so that it is highlighted).

- 4 To set the priority (when “[Q] CHIME [Q] PRIORITY” is displayed), press **ZOOM/WIDE**, and then press  to select the target priority (so that it is highlighted).

* If you will not set the priority, skip this step and press **TALK** or lift the handset. Chime paging begins. (Chime paging begins after a ring of tone when the target zone is other than the zone you belongs.)

- 5 Press **TALK** or **ZOOM/WIDE**, or lift the handset (when “[Q] CHIME” is displayed). Chime paging begins.

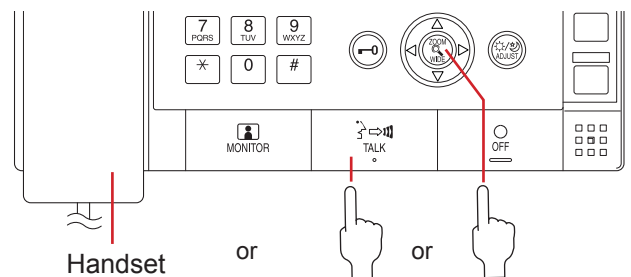

Making chime paging automatically

You can also set chime page automatically on a preset schedule in the System setting on a PC.

OTHER FUNCTIONS (combined with connected external devices)

Activating room sub stations, IS-SS-2G audio door stations and central control units by detecting contact input

You can set room sub stations, IS-SS-2G audio door stations and central control units to perform the designated operations when detecting an external input. Operations differ from the settings in the System setting on a PC.

Room sub station/IS-SS-2G audio door station

(Example 1: when the action is set to call with an appropriate priority)

When a sensor connected to the room sub station or IS-SS-2G audio door station detects abnormality, or a connected call button is pressed, the room sub station or IS-SS-2G audio door station calls the designated master stations.

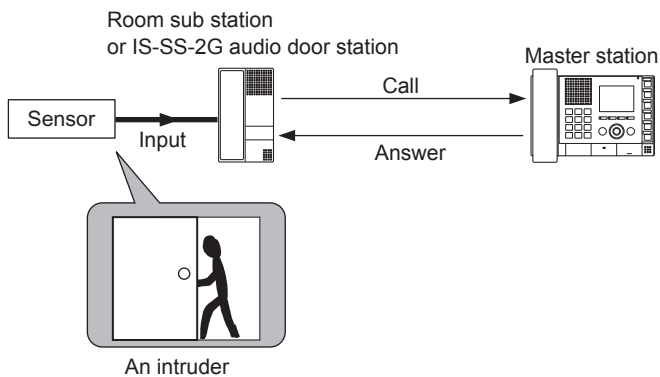

(Example 2: when the action is set to answering the page)

When receiving paging from a master station, by inputting an external signal (for example, by pressing an external button connected to the room sub station), answering the page can be possible.

NOTE:

When using an IS-SS-2G audio door station, only a calling with the "Urgent" priority is possible.

Central control unit

(Example: when the trigger condition is set to broadcast chime)

When a sensor connected to the central control unit detects abnormality or a connected external button is pressed, the central control unit transmits a chime to the set zone.

* It is also possible to set to stop the current paging.

Activating an external device by detecting the designated action

You can set central control units, add-on control units and room sub control units to activate the connected external devices when detecting the designated action: a call with an appropriate priority, door release, external sound input (central control unit only) or PA output. The trigger condition can be designated by the settings in the System setting on a PC.

TECHNICAL PRECAUTIONS

- **Cleaning:**
Clean all the units with a soft cloth dampened with a neutral household cleanser. Do not use an abrasive cleaner or cloth.
Door stations are water resistant, however clean all the units with a soft cloth dampened with a neutral household cleanser. Do not use an abrasive cleaner or cloth.
- If you are experiencing difficulties in the use of the system, please check our website at <http://www.aiphone.net/>. (Our website does not support IPv6.)

AVAILABLE CHARACTER LIST

The following are the characters that can be entered with each of the dial keys on the master station for station or zone names and numbers.
Some characters are available with a key and they are switched whenever the key is pressed.

Dial key	Characters and number that can be entered with a key																		
	Number	Characters																	
1	1	.	-	?	!	'	@	_	/	1									
2 (ABC)	2	A	B	C	2														
3 (DEF)	3	D	E	F	3														
4 (GHI)	4	G	H	I	4														
5 (JKL)	5	J	K	L	5														
6 (MNO)	6	M	N	O	6														
7 (PQRS)	7	P	Q	R	S						7								
8 (TUV)	8	T	U	V	8														
9 (WXYZ)	9	W	X	Y	Z						9								
*																			
0											0	+	\$	%	&	()	;	0
#																			

SPECIFICATIONS

Central control unit (IS-CCU)

Power source	48V DC (supplied from the power supply unit)
Current consumption	Max. 800mA
Ambient temperature	0 - 40° C (+32°F - +104°F)
Talk channels · Video channels	Local system: 2 talk & 2 video channels, 1 chime
Master station(s)	Max. 4
Video door station(s)	
Audio door station(s)	Max. 4
Room sub station(s)	
Add-on control unit	Max. 2
Room sub control unit	Max. 4
IP control unit	Max. 1
Video output	NTSC BNC (Video channel 1,2)
LAN	Ethernet (10 BASE-T, 100 BASE-TX)
Mounting	Rack-mount (19-inch, 2U rack) or wall-mount
Material	Steel plate
Color	Black
Weight	Approx. 4.0kg (8.82 lbs.)

Add-on control unit (IS-SCU)

Power source	48V DC (supplied from the power supply unit)
Current consumption	Max. 1.2A
Ambient temperature	0 - 40° C (+32°F - +104°F)
Talk channels · Video channels	Local system: 2 talk & 2 video channels, 1 chime
Master station(s)	Max. 8
Video door station(s)	
Audio door station(s)	Max. 8
Room sub station(s)	
Video output	NTSC BNC (Video channel 1,2)
Mounting	Rack-mount (19-inch, 2U rack) or wall-mount
Material	Steel plate
Color	Black
Weight	Approx. 4.0kg (8.82 lbs.)

Room sub control unit (IS-RCU)

Power source	48V DC (supplied from the power supply unit)
Current consumption	Max. 1.8A
Ambient temperature	0 - 40° C (+32°F - +104°F)
Talk channels	Local system: 2 talk channels, 1 chime
Audio door station(s) Room sub station(s)	Max. 30
Mounting	Rack-mount (19-inch, 2U rack) or wall-mount
Material	Steel plate
Color	Black
Weight	Approx. 4.0kg (8.82 lbs.)

Color monitor master station (IS-MV)

Power source	Supplied from the central control unit or add-on control unit
Communication	Handset: Simultaneous communication (When press-to-talk (PTT) is not set) Hands-free: Auto-voice actuation or Press-to-talk (PTT)
Ambient temperature	0 - 40°C (+32°F - +104°F)
Monitor	3.5 inch color LCD monitor
Call history	Call record: 20 Reception record: 20
Paging capacity	Simultaneous paging to max. 5 zones and/or stations
Mounting	Desktop use (with or without desktop stand) or wall-mount
Electrical box	1 or 3-gang box*
Material	Flame resisting ABS resin
Color	Black
Weight	Approx. 820g (1.81 lbs.)

*: 1-gang box.....For wiring only (Fix the unit to the wall directly)

3-gang box.....For wiring and fixing the unit

Vandal-resistant video door station (surface-mount) (IS-DV)

Power source	Supplied from the central control unit or add-on control unit
Communication	Open voice hands-free communication
Ambient temperature	-10 - 60° C (+14°F - +140°F)
Camera	1/4-inch color CMOS
Minimum illumination	5 Lux
Camera angle	Wide: Approx. 170° (horizontal)
Mounting	Surface-wall mount (directly to wall)
Material	Front panel: Aluminum die-cast Main unit: Flame resisting PC+ABS resin
Color	Front panel: Dull-gray silver
Weight	Approx. 520g (1.15 lbs.)
Remarks	Weather-resistant

Vandal-resistant video door station (flush-mount) (IS-DVF)

Power source	Supplied from the central control unit or add-on control unit
Communication	Open voice hands-free communication
Ambient temperature	-10 - 60° C (+14°F - +140°F)
Camera	1/4-inch color CMOS
Minimum illumination	5 Lux
Camera angle	Wide: Approx.170° (horizontal)
Mounting	Flush-mount
Electrical box	Not used (mounts on built-in back box.)
Material	Front panel: Stainless steel Main unit: Flame resisting PC+ABS resin
Color	Front panel: Stainless steel, vertical hair-line processed Back box: Black
Weight	Approx. 810g (1.79 lbs.) Back box: Approx. 600g (1.32 lbs.)
Remarks	Weather-resistant

Vandal-resistant audio door station (flash-mount) (IS-SS)

Power source	Supplied from the central control unit, add-on control unit or room sub control unit
Communication	Open voice hands-free communication
Ambient temperature	-10 - 60°C (+14°F - +140°F)
Mounting	Flush-mount
Electrical box	Not used (mounts on built-in back box.)
Material	Front panel: Stainless steel Main unit: Flame resisting PC+ABC resin
Color	Front panel: Stainless steel, vertical hair-line processed Back box: Black
Weight	Approx. 820g (1.81 lbs.) Back box: Approx. 600g (1.32 lbs.)
Remarks	Weather-resistant

Vandal-resistant audio door station (flash-mount) (IS-SS-2G)

Power source	Supplied from the central control unit, add-on control unit or room sub control unit
Communication	Open voice hands-free communication
Ambient temperature	-10 - 60°C (+14°F - +140°F)
Mounting	Flush-mount
Electrical box	2-gang box
Material	Front panel: Stainless steel Main unit: Flame resisting PC+ABC resin
Color	Front panel: Stainless steel, vertical hair-line processed
Weight	Approx. 370g (0.82 lbs.)
Remarks	Weather-resistant (Protection class: IP54)

Room sub station (IS-RS)

Power source	Supplied from the central control unit, add-on control unit or room sub control unit
Communication	Handset: Simultaneous communication Hands-free: Auto-voice actuation
Ambient temperature	0 - 40°C (+32°F - +104°F)
Mounting	Surface-wall mount (directly to wall or electrical box)
Electrical box	1-gang box
Material	Flame resisting ABS resin
Color	Black
Weight	Approx. 530g (1.17 lbs.)

Power supply unit (IS-PU-UL, IS-PU-S)

Power source	AC 100 - 240V, 50/60Hz.
Power consumption	120W
Ambient temperature	0 - 40°C (+32°F - +104°F)
(Secondary) Output voltage	DC 48V
(Secondary) Output current	2.1A
Mounting	Wall-mount (with IS-RACK) or rack-mount (with IS-RACK)
Material	Steel plate
Color	Black
Weight	Approx. 1.5kg (3.31 lbs.)

WARRANTY

Aiphone warrants its products to be free from defects of material and workmanship under normal use and service for a period of two years after delivery to the ultimate user and will repair free of charge or replace at no charge, should it become defective upon which examination shall disclose to be defective and under warranty. Aiphone reserves unto itself the sole right to make the final decision whether there is a defect in materials and/or workmanship; and whether or not the product is within the warranty. This warranty shall not apply to any Aiphone product which has been subject to misuse, neglect, accident, power surge, or to use in violation of instructions furnished, nor extended to units which have been repaired or altered outside of the factory. This warranty does not cover batteries or damage caused by batteries used in connection with the unit. This warranty covers bench repairs only, and any repairs must be made at the shop or place designated in writing by Aiphone. This warranty is limited to the standard specifications listed in the operation manual. This warranty does not cover any supplementary function of a third party product that is added by users or suppliers. Please note that any damage or other issues caused by failure of function or interconnection with Aiphone products is also not covered by this warranty. Aiphone will not be responsible for any costs incurred involving on site service calls. Aiphone will not provide compensation for any loss or damage incurred by the breakdown or malfunction of its products during use, or for any consequent inconvenience or losses that may result.

The object area of  is the EU.

FCC

This device complies with Part 15 of the FCC Rules. Operation is subject to the following two conditions: (1) this device may not cause harmful interference, and (2) this device must accept any interference received, including interference that may cause undesired operation.

This equipment has been tested and found to comply with the limits for a Class B digital device, pursuant to Part 15 of the FCC Rules. These limits are designed to provide reasonable protection against harmful interference in a residential installation. This equipment generates, uses, and can radiate radio frequency energy, and if not installed and used in accordance with the instructions, may cause harmful interference to radio communications. However, there is no guarantee that interference will not occur in a particular installation. If this equipment does cause harmful interference to radio or television reception, which can be determined by turning the equipment off and on, the user is encouraged to try to correct the interference by one or more of the following measures:

- Reorient or relocate the receiving antenna
- Connect the equipment to an outlet on a circuit different from that to which the receiver is connected. Increase the separation between the equipment and receiver.
- Consult the dealer or an experienced radio/TV technician for help.

 **AIPHONE**®
Providing Peace of Mind
<http://www.aiphone.net/>

AIPHONE CO., LTD., NAGOYA, JAPAN